

GTW.75

Pneumatischer Antrieb mit beidseitig einstellbaren Endlagen
 Pneumatic actuator with double limit stop

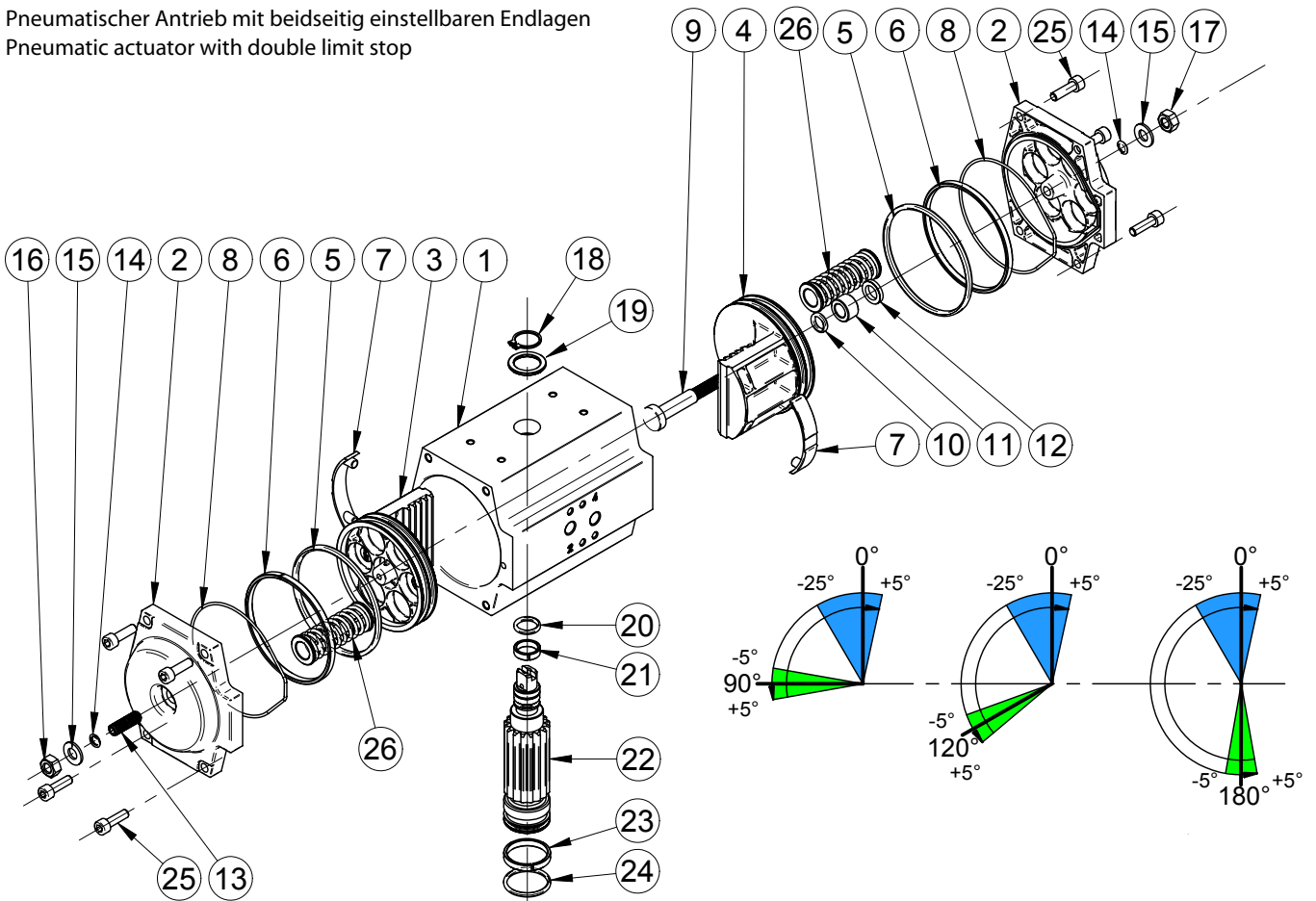

ERSATZTEILLISTE / SPARE PARTS LIST

Pos.	Beschreibung	Description	Menge Q.ty	Ersatzteilset / Spare parts set							
				Set 1,5	Set 2	Set 3	Set 4	Set 6	Set 7	Set 8	
1	Gehäuse	Actuator body	1	-	-	-	-	-	-	-	
2	Seitendeckel	Actuator end cap	2	1	-	-	-	-	-	-	
3	Kolben ohne Durchgangsbohrung	Blind piston	1	-	1	-	-	-	-	-	
4	Kolben mit Durchgangsbohrung	Drilled piston	1	-	-	1	-	-	-	-	
5	O-Ring-Kolben	Piston sealing O-Ring	2	-	1	1	-	-	2	-	
6	Führungsring-Kolben	Piston guide ring	2	-	1	1	-	-	-	2	
7	Gleitelement-Kolben	Piston guide skate	2	-	7	1	-	-	-	2	
8	O-Ring-Gehäusedeckel	End cap sealing O-Ring	2	1	-	-	-	-	2	-	
9	Innere Hubeinstellschraube	Internal travel stop rod	1	-	-	-	-	-	-	-	
10	O-Ring für innere Hubeinstellschraube	Internal travel stop rod sealing O-Ring	1	-	-	1	-	-	-	-	
11	Gleithülse für innere Hubeinstellschraube	Internal stop rod guide bush	1	-	-	1	-	-	-	-	
12	Scheibe-Hubeinstellschraube-Innen	Rod guide bush stop washer	1	-	-	-	-	-	-	-	
13	Äussere Hubeinstellschraube	External travel stop nut	1	-	-	-	-	1	-	-	
14	O-Ring für äussere Hubeinstellschraube	Stop sealing O-Ring	2	-	-	-	-	1	2	-	
15	O-Ring-Scheibe	O-Ring stop washer	2	-	-	-	-	1	-	-	
16	Kontermutter-Hubeinstellschraube aussen	External stop nut	1	-	-	-	-	1	-	-	
17	Kontermutter-Hubeinstellschraube innen	Internal stop nut (yellow)	1	-	-	-	-	-	-	-	
18	Seegering	Pinion stop circlips	1	-	-	-	1	-	-	-	
19	Anlaufscheibe	Upper pinion washer	1	-	-	-	1	-	-	-	
20	O-Ring-Ritzel-oben	Upper pinion O-Ring sealing	1	-	-	-	1	-	1	-	
21	Führungsring-Ritzel-oben	Upper pinion guide ring	1	-	-	-	1	-	-	1	
22	Ritzel	Pinion	1	-	-	-	1	-	-	-	
23	Führungsring-Ritzel-unten	Lower pinion guide ring	1	-	-	-	1	-	-	1	
24	O-Ring-Ritzel-unten	Lower pinion O-Ring sealing	1	-	-	-	1	-	24	-	
25	Schrauben-Seitendeckel	End cap screws	8	4	-	-	-	-	-	-	
26	Rückstellfedern	Spring cartridges	0-12	-	-	-	-	-	-	-	

Set 1,4 = Seitendeckel, komplett / Cap, complete
 Set 2 = Kolben ohne Durchgangsbohrung, komplett / Blind piston, complete
 Set 3 = Kolben mit Durchgangsbohrung, komplett / Drilled piston kit, complete
 Set 4 = Ritzel, komplett / Shaft complete
 Set 6 = Innere Hubeinstellschraube, komplett / External stop kit, complete
 Set 7 = Dichtungssatz / Seal kit
 Set 8 = Verschleißteilsatz / Guide kit