

2.14

Products for Explosion Hazardous Environment



General information on Hafner products for explosion hazardous environment

Since July 1, 2003, devices and protective systems for use in explosion protection areas must be approved according to Directive 94/9 / EC - known as the ATEX Directive. This has been replaced by the latest ATEX 2014/34 / EU directive.

Essential when applying the ATEX directive:

- Non-electrical equipment (e.g. pneumatic actuators and valves) fall within the scope of application.
- Basic safety requirements are defined.
- The devices are divided into groups and categories, which in turn are assigned to corresponding zones. Zones are to be defined by the operator in accordance with ATEX directive 137.
- The CE mark is mandatory.
- Each device must be accompanied by an operating manual and a declaration of conformity.
- The directive also takes dust explosion protection into account.
- It applies to mining and all other potentially explosive areas

When and where can an explosion occur?

Explosions can always occur where flammable gases, liquids or dusts are produced, transported or stored. Under certain conditions, explosive mixtures arise in connection with air. In such potentially explosive areas, a small spark is often enough to trigger an explosion. Areas at risk of explosion can be found, for example, in chemical factories, refineries, tank systems, paint factories or sewage treatment plants and in other areas in which dust-forming bulk materials are processed or transported, e.g. in grain mills, feed mills and cement plants.

What are potential ignition sources?

Exemplary electrical ignition sources:	Exemplary mechanical ignition sources:	Other exemplary ignition sources:
<ul style="list-style-type: none">• Sparking that occurs when contacts are opened• Electrical equalizing currents• Electrostatic discharge• Hot surfaces of coils	<ul style="list-style-type: none">• Hot surfaces caused by friction• Adiabatic compression• Sparks generated by hitting	<ul style="list-style-type: none">• Open fire• Overheating bearings or brakes• Self-ignition (exothermic compounds)• Lightning strike

Products subject to approval according to the ATEX directive

- Electrical equipment
- Non-electrical equipment such as:
 - Cylinders
 - Rodless cylinders
 - Valves
 - Hoses (must be antistatic)

This affects all devices that have their own potential ignition source (see above).

Products not subject to approval according to the ATEX directive

The following product examples do not have their own ignition sources and can be used in certain hazard zones in accordance with the manufacturer's instructions:

- Pneumatic accessories
- Mechanical accessories
- Air preparation units
- Fittings
- Check- and flow regulator valves

But: These devices must be protected from falling objects as well.

Overview of product groups, categories and zones according to ATEX 2014/34 / EU and ATEX 137

According to the ATEX 2014 directive, the manufacturer must assess his products and label them accordingly:



- Divide into product groups and categories for use in different zones
- Divide into temperature classes
- Divide into explosion groups
- Determination of the permissible ambient temperatures

In accordance with ATEX 137, the system builder or operator must assess the system and define appropriate protective measures (e.g. in the context of an explosion protection document):



- Divide the system into zones according to the hazard potentials determined
- Determine temperature classes
- Determine explosion groups
- Determination of the occurring ambient temperatures

The plant manufacturer is responsible for ensuring that the selected components meet the requirements.

The ATEX directive differentiates between an electrical and non-electrical device.

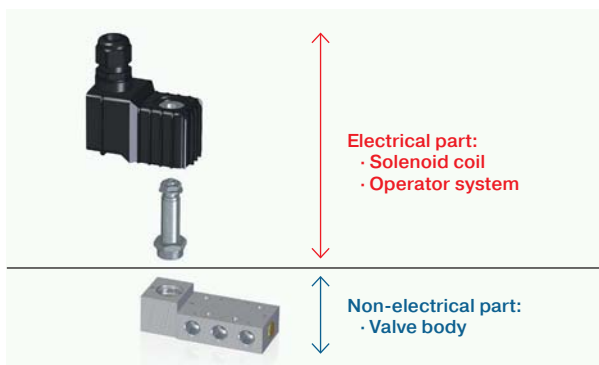

Electrical devices are, for example, solenoid systems. Cylinders, valves and the mechanical part of the solenoid valves are considered as “non-electrical devices”.

Electrical and non-electrical devices are identified using the same scheme.

1. Example identification of a **non-electrical device**:



II	2G	Ex	h	IIC	T6	Gb	X
II	2G	Ex	h	IIC	T6	Gb	X



The two identifications differ only in terms of the type of ignition.

Example identification of an **electrical device**:



II	2G	Ex	e mb	IIC	T6	Gb	X
II	2G	Ex	e mb	IIC	T6	Gb	X

Gas atmosphere

Dust atmosphere

Product group

Equipment category / zone

Ex-identification

Ignition protection

Explosion group

Temperature class

Equipment protection level

Special conditions

In addition, the ambient temperature in which it is permitted to be used (e.g. $-10^{\circ}\text{C} \leq T_a \leq +50^{\circ}\text{C}$) is also printed on the products.

In the case of devices that have both markings, the respective lower Ex characteristic values shall be used.

In addition, a CE mark is mandatory.

General information on Hafner products for explosion hazardous environment

Product group:

Product group I

Products from product group I are distinguished between M1 and M2. Both are suitable for mining applications. They are not in our focus as Hafner does not offer suitable equipment.

Product group II

All other products for explosion hazardous environment are in this group.

Category:

Gas:

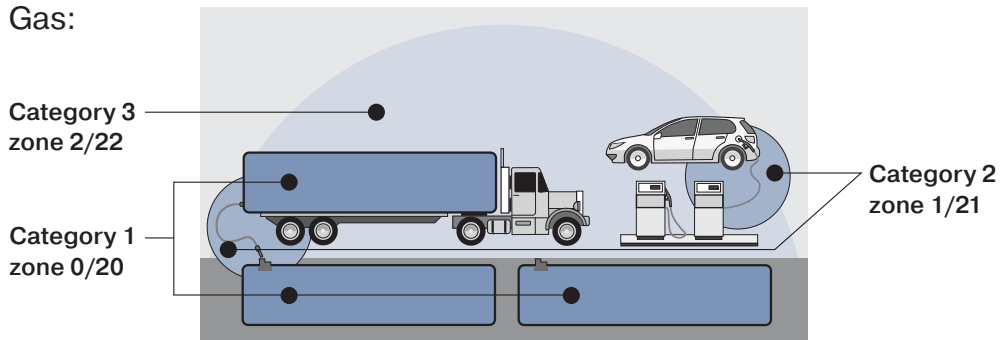

Dust:

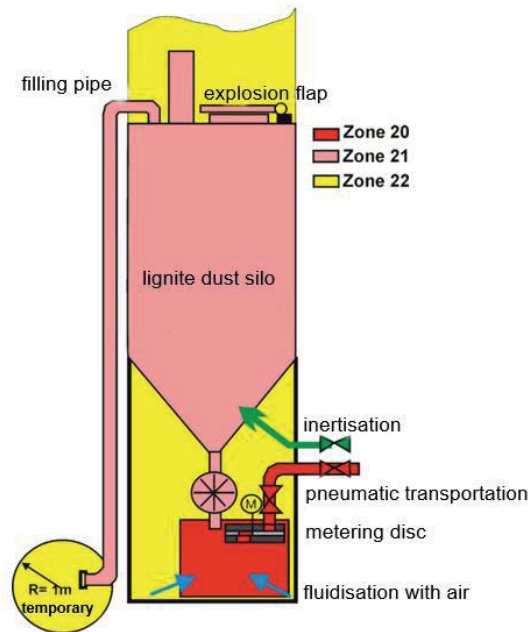

Category I

An area in which an explosive mixture is continuously present or present for long periods > 1000 hours/year.

Category II

An area in which an explosive mixture is occasionally present 10 – 1000 hours/year.

Category III

An area in which an explosive mixture is not likely to occur in normal operation and if it occurs it will exist only for a short time < 10 hours/year.

General information on Hafner products for explosion hazardous environment

	Zones for Gases	Zones for Dust
Category 1	Zone O Area in which an explosion hazardous atmosphere consisting of air and inflammable gases, vapors or fog is present constantly or over a longer period of time. > 1000 hours/year	Zone 20 Area in which an explosion hazardous atmosphere consisting of a dust-cloud or a mix of air and dust is present constantly or over a longer period of time. > 1000 hours/year
Category 2	Zone 1 Area in which there is a probability that under normal conditions an explosion hazardous atmosphere consisting of air and inflammable gases, vapors or fog can be present. 10 – 1000 hours/year	Zone 21 Area in which there is a probability that under normal conditions an explosion hazardous atmosphere consisting of a dust-cloud or a mix of air and dust can be present. 10 – 1000 hours/year
Category 3	Zone 2 Area in which once and a while an explosion hazardous atmosphere consisting of air and inflammable gases, steam or vapors can be present. < 10 hours/year	Zone 22 Area in which once and a while an explosion hazardous atmosphere consisting of a dust-cloud or a mix of air and dust can be present. < 10 hours/year

Covered by the Hafner product range

Comparison of product category according to ISO 2014/34/EU with product category according to EN ISO 80079-36:

EN ISO 80079-36		Directive 2014/34/EU	
EPL	Group	Product group	Category
Ma	I (Mining)	I (Mining)	M1
Mb			M2
Ga	II (Gas)	II (Non-mining applications)	1G
Gb			2G
Gc			3G
Da	III (Dust)		1D
Db			2D
Dc			3D

Ignition protection (examples):

	General definition:	For Hafner products:
c	Constructional safety	general protection for mechanical ATEX
i	Intrinsic safety	called ia for solenoids
na	Non sparking	
mb	Encapsulation	with cable
me	Encapsulation enhanced safety	called Ex emb with junction box
d	Flameproof enclosure	with junction box
dm	Flameproof encapsulation	with junction box

General information on Hafner products for explosion hazardous environment

Explosion group

Depending on the type of protection, explosion-protected equipment for gases, mists and vapours is divided into three explosion groups (IIA-IIB-IIC). The explosion group is a measure of the ignition transmission capability of gases (explosive atmosphere). The requirements on the equipment increase from IIA to IIC. Consequently, products classified IIC/IIIC can also be used in IIB/IIIB and IIA/IIIA.

Gas group device	Use in gas groups	Example	
IIA	IIA	Propane	Danger increases
IIB	IIA + IIB	Ethylene	
IIC	IIA + IIB + IIC	Hydrogen	

Temperatur classes:

Flammable gases and vapours are divided into temperature classes in accordance with their flammability. The ignition temperature is the lowest temperature of a heated surface at which the ignition of a gas/air or vapour/air mixture occurs. In other words, it is the lowest temperature value at which a hot surface can ignite the corresponding explosive atmosphere.





The maximum surface temperature of electrical equipment must always be lower than the ignition temperature of the gas/air or vapour/air mixture in which it is used.

Equipment of a higher temperature class (e.g. T6) can therefore also be used for lower temperature classes (T1-T5).

Temperature class	Temperature range of the mix (°C)	Max. surface temperature (°C)	Typical gases
T1	≥ 450°C	450°C	Methane, acetone, ammonia, methanol, propane, acetic acid, town gas, hydrogen
T2	≥ 300 - 450°C	300°C	Ethylene, acetylene
T3	≥ 200 - 300°C	200°C	Petroleum, diesel, heating oils, hydrogen sulphide
T4	≥ 135 - 200°C	135°C	Acetaldehyde, ethyl ether
T5	≥ 100 - 135°C	100°C	
T6	≥ 85 - 100°C	85°C	Carbon disulphide



Temperature classes, heating of the devices and ambient temperature

On non-electrical devices, the temperature range in which the devices can be operated must be specified. The ambient temperature range is marked by "Ta." on any Hafner solenoid valve (example):

 II 2 G Ex h IIC T6 Gb
 -10°C ≤ Ta ≤ +50°C

 II 2 D Ex h IIIC T80°C
 Db -10°C ≤ Ta ≤ +50°C

On electrical and non-electrical devices, the maximum surface temperature is also specified. For gas atmosphere as temperature class, for dust atmosphere as absolute temperature [°C].

The temperature specification for dust is 5 °C below the maximum temperature of the temperature class.

 II 2G Ex e mb IIC T6 Gb
 II 2D Ex tb mb IIIC T80°C Db

General information on Hafner products for explosion hazardous environment

If the permissible ambient temperature range is not printed on the device, you can find it in the instructions and declaration of conformity.

Please note that solenoid valves can have a different ambient temperature range and maximum surface temperature for the valve body (non-electrical part) and the solenoid system (electrical part).

The user is limited by the lower values for the ambient temperature. The highest specified maximum surface temperature represents the relevant restriction for the application.

Example: valve has T6 imprint, coil T4. Then T4 counts.

Products without an own potential source of ignition

For products without an own potential source of ignition, Hafner issues separate ATEX declarations. These products are not marked in terms of the ATEX directive, but an ignition risk assessment has been carried out.

HAFNER Pneumatika Kft.
H-9228 Halászi, Puski út 3.
www.hafner-pneumatika.com
ertekeletes@hafner-pneumatika.com



ATEX DECLARATION FOR BLOCK FORM FLOW REGULATORS

The company **HAFNER Pneumatika Kft.**, as manufacturer hereby declares that the products

block form flow regulators (type number: DRN...)

may not be put into service before the system in which it will be incorporated is declared to comply with the provisions of the European directive 2006/42/EC about the Safety of Machines, and with the regulations transposing it into national law.

According to the directive 2014/34/EU, Article 1 and Article 2, these products do not fall under the scope of the ATEX directive, because they are not capable of causing an explosion through their own potential sources of ignition.

So, these products are not marked in terms of the ATEX directive. An ignition risk assessment has been carried out.

If the installation regulations for devices and facilities in potentially explosive atmospheres and areas are compiled with (e.g. ISO 80079-36, EN 60079-14, EN 61241-14), the equipment can be used as following:
Group II, Category 2, Gas (II 2 G): for Zones 1, 2, in explosion group IIC.
Group II, Category 2, Dust (II 2 D): for Zones 21, 22, in explosion group IIIC.
Permitted temperature class: T6.
Allowed ambient temperature: $-10^{\circ}\text{C} \leq T_a \leq +50^{\circ}\text{C}$.

Important notes:

- The installation regulations valid in the designated country of use are to be observed.
- Dust deposits are to be removed regularly.
- The installation and operation instructions provided by the manufacturer are to be considered compellingly.
- Compressed air must be produced outside of the hazardous area.
- The use of any flammable or explosive flow medium is not permitted.
- Changing of the above-mentioned products is not permitted.
- Connect conductive metal parts together for potential equation and ground the entire system.
- If the above-mentioned products are built-in in a higher-level machine / tool / equipment, the risks of this machine / tool / equipment have to be assessed by the manufacturer of the higher-level machine / tool / equipment.

13.10.2020, Halászi



 Gergely Ujváry
 General Manager

FE-M3-0042 v2
Page: 1 / 1

| HAFNER Pneumatika Kft. | H-9228 Halászi, Puski út 3. | Tel.: +36-96-573-012 |
 | VAT-Nr.: 10579785-2-08 | ertekeletes@hafner-pneumatika.com | www.hafner-pneumatika.com |

According to the directive 2014/34/EU, Article 1 and Article 2, these products do not fall under the scope of the ATEX directive.

Type	Description	Catalogue Page
ES ... / VA ...	AND / OR gates	2.4.5.1
SE ...	Quick-exhaust valves	2.4.5.2
DRN ...	NAMUR flow regulators	2.10.1, 2.10.2
UB 701	NAMUR air-recirculation block	2.10.3

Other products can be evaluated on customer request.

General information on Hafner products for explosion hazardous environment

Temperature classes, heating of the devices and ambient temperature

The following product selection tree can help to determine the correct type of ignition protection. However, only ATEX products are considered here. Some of these are also certified per IECEx. See table on page 2.14.3.1. CSA/FM approved coils can be found on page 2.14.3.2.3.

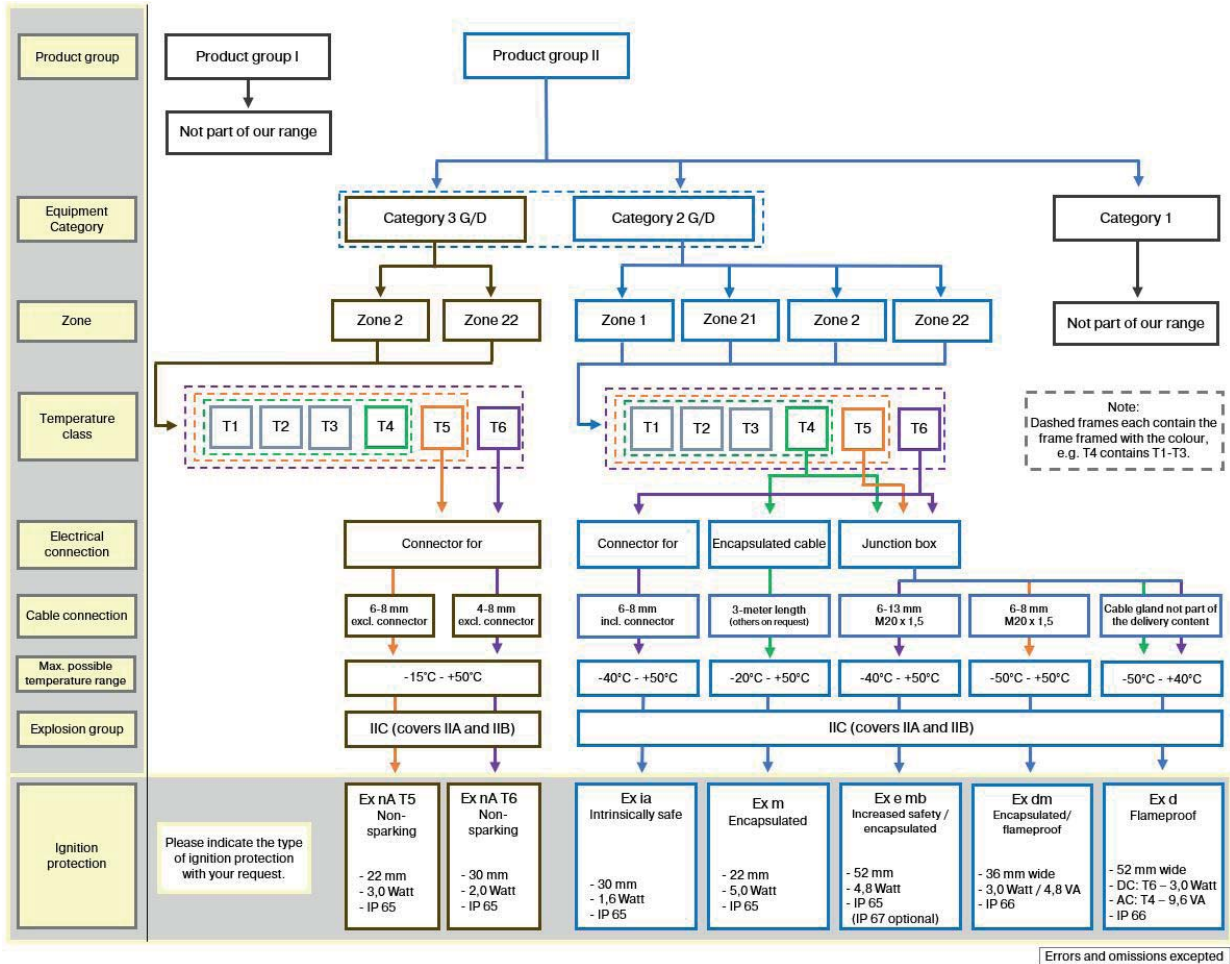

Non-electric valves for explosion hazardous environment

The following **manually and mechanically actuated valves** are available for the use in explosion hazardous environment in zones 2 and 22 gas and dust:

Type	Function	Port size	Further inform. on valve on page
BV 311 301 EX	3/2-way, stem actuated	G 1/8"	2.1.1.4
BV 511 301 EX	5/2-way, stem actuated	G 1/8"	2.1.2.2
BA 311 301 EX	3/2-way, for panel mounting	G 1/8"	2.2.1
BA 511 301 EX	5/2-way, for panel mounting	G 1/8"	2.2.2
BA 22_	Actuator elements		2.2.3

Valve for zone 1 and 21 available on request.



The products are marked:

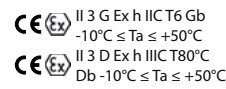

Delivery contains a manual as well as a declaration of conformity.

A declaration of the manufacturer that the actuation elements BA 22_ do not require a certification can be supplied on request. For the use in dust atmosphere we recommend the use of a dust protection cap.

The following **pneumatically actuated valves** are available for the use in explosion hazardous environ-

Type	Function	Port size	Further information on valve on page		
			Aluminum	Low Temp.	Stainl. Steel
P 310 502 EX	3/2-way, single sol.	G 1/8"	2.4.1.1		
P 310 501 EX	3/2-way, single sol.	G 1/8"	2.4.1.2	2.11.4.1	
P 310 701 EX	3/2-way, single sol.	G 1/4" - 1/4" NPT	2.4.1.2	2.11.4.1	2.12.3.1
P 310 801 EX	3/2-way, single sol.	G 1/4"	2.4.1.2		
P 310 101 EX	3/2-way, single sol.	G 3/8"	2.4.1.3		
P 310 121 EX	3/2-way, single sol.	G 1/2" - 1/2" NPT	2.4.1.3	2.11.4.2	2.12.3.1
P 320 502 EX	3/2-way, double sol.	G 1/8"	2.4.1.5		
P 320 501 EX	3/2-way, double sol.	G 1/8"	2.4.1.6	2.11.4.1	
P 320 701 EX	3/2-way, double sol.	G 1/4" - 1/4" NPT	2.4.1.6	2.11.4.1	
P 320 801 EX	3/2-way, double sol.	G 1/4"	2.4.1.6		
P 320 101 EX	3/2-way, double sol.	G 3/8"	2.4.1.7		
P 320 121 EX	3/2-way, double sol.	G 1/2" - 1/2" NPT	2.4.1.7		
P 510 502 EX	5/2-way, single sol.	G 1/8"	2.4.2.1		
P 510 501 EX	5/2-way, single sol.	G 1/8"	2.4.2.2	2.11.4.3	
P 510 701 EX	5/2-way, single sol.	G 1/4" - 1/4" NPT	2.4.2.2	2.11.4.3	2.12.3.2
P 510 801 EX	5/2-way, single sol.	G 1/4"	2.4.2.2		
P 510 101 EX	5/2-way, single sol.	G 3/8"	2.4.2.3		
P 510 121 EX	5/2-way, single sol.	G 1/2" - 1/2" NPT	2.4.2.3	2.11.4.3	2.12.3.2
P 520 502 EX	5/2-way, double sol.	G 1/8"	2.4.2.5		
P 520 501 EX	5/2-way, double sol.	G 1/8"	2.4.2.6	2.11.4.4	
P 520 701 EX	5/2-way, double sol.	G 1/4" - 1/4" NPT	2.4.2.6	2.11.4.4	2.12.3.3
P 520 801 EX	5/2-way, double sol.	G 1/4"	2.4.2.6		
P 520 101 EX	5/2-way, double sol.	G 3/8"	2.4.2.7		
P 520 121 EX	5/2-way, double sol.	G 1/2" - 1/2" NPT	2.4.2.7		2.12.3.3
P 531 501 EX	5/3-way, centre closed	G 1/8"	2.4.3.1	2.11.4.4	
P 531 701 EX	5/3-way, centre closed	G 1/4" - 1/4" NPT	2.4.3.1	2.11.4.4	2.12.3.3
P 531 801 EX	5/3-way, centre closed	G 1/4"	2.4.3.1		
P 531 101 EX	5/3-way, centre closed	G 3/8"	2.4.3.2		
P 531 121 EX	5/3-way, centre closed	G 1/2" - 1/2" NPT	2.4.3.2		2.12.3.3
P 532 501 EX	5/3-way, centre exhausted	G 1/8"	2.4.3.1	2.11.4.4	
P 532 701 EX	5/3-way, centre exhausted	G 1/4" - 1/4" NPT	2.4.3.1	2.11.4.4	2.12.3.3
P 532 801 EX	5/3-way, centre exhausted	G 1/4"	2.4.3.1		
P 532 101 EX	5/3-way, centre exhausted	G 3/8"	2.4.3.2		
P 532 121 EX	5/3-way, centre exhausted	G 1/2" - 1/2" NPT	2.4.3.2		2.12.3.3
P 533 501 EX	5/3-way, centre pressurised	G 1/8"	2.4.3.1	2.11.4.4	
P 533 701 EX	5/3-way, centre pressurised	G 1/4" - 1/4" NPT	2.4.3.1	2.11.4.4	2.12.3.3
P 533 801 EX	5/3-way, centre pressurised	G 1/4"	2.4.3.1		
P 533 101 EX	5/3-way, centre pressurised	G 3/8"	2.4.3.2		
P 533 121 EX	5/3-way, centre pressurised	G 1/2" - 1/2" NPT	2.4.3.2		2.12.3.3



ment in zone zone 1, 2, 21, 22 gas and dust:
The products are marked:

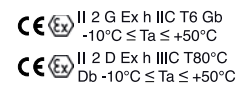













Delivery contains a manual as well as a declaration of conformity. ATEX-certified pneumatically actuated valves for low-temperature applications as well as stainless steel products are available on request.

Solenoid valves for explosion hazardous environment

General information – overview

Our customers have the choice between numerous solenoid systems of different ignition protection types. Those can be combined with valves made from aluminum or stainless steel designed for different temperature classes.

Valve	Temp.-range	Ignition protection type		
		Ex na (non-sparking)	Ex ia (intrinsically safe)	Ex m (encapsulation)
				
Aluminum	-10°C ... + 50°C	✓	✓	✓
Stainless steel 	-10°C ... + 50°C	✓	✓	✓
Aluminum	-40°C ... + 50°C ❄️	n.a.	✓	n.a.
Stainless steel 	-40°C ... + 50°C ❄️	n.a.	✓	n.a.
Zone		2, 22	1, 21, 2, 22	1, 21, 2, 22
IEC-Ex rated			✓	✓
Reference:		2.14.3.4.3	2.14.3.3.5	2.14.3.2.4

Valve	Temp.-range	Ignition protection class		
		Ex e mb (encapsulation with junction box)	Ex dm (encapsulation with junction box)	Ex d (flameproof with junction box)
				
Aluminum	-10°C ... + 50°C	✓	✓	✓
Stainless steel 	-10°C ... + 50°C	✓	✓	✓
Aluminum	-40°C ... + 50°C ❄️	✓		✓
Stainless steel 	-40°C ... + 50°C ❄️	✓		✓
Zone		1, 21, 2, 22	1, 21, 2, 22	1, 21, 2, 22
IEC-Ex rated		✓		✓
Reference:		2.14.3.5.4	2.14.3.7.5	2.14.3.6.5

ATEX-approved valves – Ex m – standard temperature range – aluminum



Material: Aluminum, anodized
 Zone: 1, 2, 21, 22
 Temperature range: -10°C ... +50°C
 Ignition protection type: Ex m (encapsulation)
 Temperature class: T4

Marking on valve

CE Ex II 2 G Ex h IIC T6 Gb
 -10°C ≤ Ta ≤ +50°C
 CE Ex II 2 D Ex h IIIC T80°C
 Db -10°C ≤ Ta ≤ +50°C

A low temperature version for -20°C ... +50°C is also available on request. Please note that the system is restricted by the minimum ambient temperature for the coil of -20°C.

The following solenoid valves are available:

Type	Function	Port size	Installation	Further inform. on valve
MH 210 501 Ex m	2/2-way, single sol.	G 1/8"	in-line	2.5.1.1.13
MH 210 701 Ex m	2/2-way, single sol.	G 1/4"	in-line	2.5.1.1.13
MH 311 012 Ex m	3/2-way direct acting	M5	in-line	2.5.1.1.2
MH 311 015 Ex m	3/2-way direct acting	G 1/8"	in-line	2.5.1.1.2
MH 311 013 Ex m	3/2-way direct acting	G 1/8"	banjo screw	2.5.1.1.8
MH 311 017 Ex m	3/2-way direct acting	G 1/4"	banjo screw	2.5.1.1.8
MH 312 Ex m	3/2-way direct acting	M5	manifold	2.5.1.2.2
MH 315 Ex m	3/2-way direct acting	G 1/8"	manifold	2.5.1.2.2
MH 310 501 Ex m	3/2-way, single sol.	G 1/8"	in-line	2.5.1.1.14
MOH 310 501 Ex m	3/2-way, n.o. single sol.	G 1/8"	in-line	2.5.1.1.14
MH 310 701 Ex m	3/2-way, single sol.	G 1/4"	in-line	2.5.1.1.14
MOH 310 701 Ex m	3/2-way, n.o. single sol.	G 1/4"	in-line	2.5.1.1.14
MH 310 801 Ex m	3/2-way, single sol.	G 1/4"	in-line	2.5.1.1.14
MOH 310 801 Ex m	3/2-way, n.o. single sol.	G 1/4"	in-line	2.5.1.1.14
MH 310 101 Ex m	3/2-way, single sol.	G 3/8"	in-line	2.5.1.1.15
MOH 310 101 Ex m	3/2-way, n.o. single sol.	G 3/8"	in-line	2.5.1.1.15
MH 310 121 Ex m	3/2-way, single sol.	G 1/2" -1/2" NPT	in-line	2.5.1.1.15
MOH 310 121 Ex m	3/2-way, n.o. single sol.	G 1/2" -1/2" NPT	in-line	2.5.1.1.15
MH 310 501 G Ex m	3/2-way, single sol.	G 1/8"	dual use*	2.5.1.1.16
MOH 310 501 G Ex m	3/2-way, n.o. single sol.	G 1/8"	dual use*	2.5.1.1.16
MH 310 701 G Ex m	3/2-way, single sol.	G 1/4" -1/4" NPT	dual use*	2.5.1.1.16
MOH 310 701 G Ex m	3/2-way, n.o. single sol.	G 1/4" -1/4" NPT	dual use*	2.5.1.1.16
MH 310 101 G Ex m	3/2-way, single sol.	G 3/8"	dual use*	2.5.1.1.17
MOH 310 101 G Ex m	3/2-way, n.o. single sol.	G 3/8"	dual use*	2.5.1.1.17
MH 310 121 G Ex m	3/2-way, single sol.	G 1/2"	dual use*	2.5.1.1.17
MOH 310 121 G Ex m	3/2-way, n.o. single sol.	G 1/2"	dual use*	2.5.1.1.17
MH 320 501 Ex m	3/2-way, double sol.	G 1/8"	in-line	2.5.1.1.18
MH 320 701 Ex m	3/2-way, double sol.	G 1/4"	in-line	2.5.1.1.18
MH 320 801 Ex m	3/2-way, double sol.	G 1/4"	in-line	2.5.1.1.18
MH 320 101 Ex m	3/2-way, double sol.	G 3/8"	in-line	2.5.1.1.19
MH 320 121 Ex m	3/2-way, double sol.	G 1/2"	in-line	2.5.1.1.19
MH 320 501 G Ex m	3/2-way, double sol.	G 1/8"	dual use*	2.5.1.1.20
MH 320 701 G Ex m	3/2-way, double sol.	G 1/4"	dual use*	2.5.1.1.20
MH 320 101 G Ex m	3/2-way, double sol.	G 3/8"	dual use*	2.5.1.1.20
MH 320 121 G Ex m	3/2-way, double sol.	G 1/2"	dual use*	2.5.1.1.20
MH 510 501 Ex m	5/2-way, single sol.	G 1/8"	in-line	2.5.2.1.3
MH 510 701 Ex m	5/2-way, single sol.	G 1/4"	in-line	2.5.2.1.3
MH 510 801 Ex m	5/2-way, single sol.	G 1/4"	in-line	2.5.2.1.3
MH 510 101 Ex m	5/2-way, single sol.	G 3/8"	in-line	2.5.2.1.4
MH 510 121 Ex m	5/2-way, single sol.	G 1/2" -1/2" NPT	in-line	2.5.2.1.4
MH 510 501 G Ex m	5/2-way, single sol.	G 1/8"	dual use*	2.5.2.1.5
MH 510 701 G Ex m	5/2-way, single sol.	G 1/4" -1/4" NPT	dual use*	2.5.2.1.5
MH 510 101 G Ex m	5/2-way, single sol.	G 3/8"	dual use*	2.5.2.1.6
MH 510 121 G Ex m	5/2-way, single sol.	G 1/2"	dual use*	2.5.2.1.6

Type	Function	Port size	Installation	Further inform. on valve
MH 510 504 Ex m	5/2-way, single sol.	5 mm orifice	manifold**	2.5.2.2.4
MH 510 704 Ex m	5/2-way, single sol.	7 mm orifice	manifold**	2.5.2.2.4
MH 520 501 Ex m	5/2-way, double sol.	G 1/8"	in-line	2.5.2.1.9
MH 520 701 Ex m	5/2-way, double sol.	G 1/4"	in-line	2.5.2.1.9
MH 520 801 Ex m	5/2-way, double sol.	G 1/4"	in-line	2.5.2.1.9
MH 520 101 Ex m	5/2-way, double sol.	G 3/8"	in-line	2.5.2.1.10
MH 520 121 Ex m	5/2-way, double sol.	G 1/2" -1/2" NPT	in-line	2.5.2.1.10
MH 520 501 G Ex m	5/2-way, double sol.	G 1/8"	dual use*	2.5.2.1.11
MH 520 701 G Ex m	5/2-way, double sol.	G 1/4" -1/4" NPT	dual use*	2.5.2.1.11
MH 520 101 G Ex m	5/2-way, double sol.	G 3/8"	dual use*	2.5.2.1.12
MH 520 121 G Ex m	5/2-way, double sol.	G 1/2"	dual use*	2.5.2.1.12
MH 520 504 Ex m	5/2-way, double sol.	5 mm orifice	manifold**	2.5.2.2.8
MH 520 704 Ex m	5/2-way, double sol.	7 mm orifice	manifold**	2.5.2.2.8
MH 53_501 Ex m	5/3-way, diff. versions	G 1/8"	in-line	2.5.3.1.2
MH 53_701 Ex m	5/3-way, diff. versions	G 1/4"	in-line	2.5.3.1.2
MH 53_801 Ex m	5/3-way, diff. versions	G 1/4"	in-line	2.5.3.1.2
MH 53_101 Ex m	5/3-way, diff. versions	G 3/8"	in-line	2.5.3.1.3
MH 53_121 Ex m	5/3-way, diff. versions	G 1/2" -1/2" NPT	in-line	2.5.3.1.3
MH 53_501 G Ex m	5/3-way, diff. versions	G 1/8"	dual use*	2.5.3.1.4
MH 53_701 G Ex m	5/3-way, diff.versions	G 1/4" -1/4" NPT	dual use*	2.5.3.1.4
MH 53_101 G Ex m	5/3-way, diff. versions	G 3/8"	dual use*	2.5.3.1.5
MH 53_121 G Ex m	5/3-way, diff. versions	G 1/2"	dual use*	2.5.3.1.5
MH 53_504 Ex m	5/3-way, diff. versions	5 mm orifice	manifold**	2.5.3.2.4
MH 53_704 Ex m	5/3-way, diff. versions	7 mm orifice	manifold**	2.5.3.2.4

Valves with interface according to NAMUR-standard

MNH 350 701 Ex m	3/2-way & 5/2-way	G 1/4" -1/4" NPT	1/4" NAMUR	2.9.1.3
MNH 310 701 Ex m	3/2-way, single sol.	G 1/4" -1/4" NPT	1/4" NAMUR	2.9.1.1.1
MNH 310 711 Ex m	3/2-way, single sol.	G 1/4"	1/4" NAMUR	2.9.1.1.1
MNH 310 121 Ex m	3/2-way, single sol.	G 1/2" -1/2" NPT	1/2" NAMUR	2.9.1.1.2
MNH 510 701 Ex m	5/2-way, single sol.	G 1/4" -1/4" NPT	1/4" NAMUR	2.9.1.2.1
MNH 510 711 Ex m	5/2-way, single sol.	G 1/4"	1/4" NAMUR	2.9.1.2.1
MNH 510 121 Ex m	5/2-way, single sol.	G 1/2" -1/2" NPT	1/2" NAMUR	2.9.1.2.2
MNH 520 701 Ex m	5/2-way, double sol.	G 1/4" -1/4" NPT	1/4" NAMUR	2.9.1.2.3
MNH 520 121 Ex m	5/2-way, double sol.	G 1/2" -1/2" NPT	1/2" NAMUR	2.9.1.2.3
MNH 53_701 Ex m	5/3-way, diff. versions	G 1/4" -1/4" NPT	1/4" NAMUR	2.9.1.4
MNH 53_121 Ex m	5/3-way, diff. versions	G 1/2" -1/2" NPT	1/2" NAMUR	2.9.1.4

* dual use valves can either be used in-line or on a manifold plate.
 ** all ports in plate

Solenoids are described on page 2.14.3.2.4.





Delivery contains valve with the appropriate operator system, coil, manual and declaration of conformity.

ATEX-approved valves – Ex m – standard temperature range – stainless steel



Material: Stainless steel, 316L 
 Zone: 1, 2, 21, 22
 Temperature range: -10°C ... +50°C
 Ignition protection type: Ex m (encapsulation)
 Temperature class: T4

Marking on valve

  II 2 G Ex h IIC T6 Gb
 -10°C ≤ Ta ≤ +50°C
  II 2 D Ex h IIIC T80°C
 Db -10°C ≤ Ta ≤ +50°C

A low temperature version for -20°C ... +50°C is also available on request. Please note that the system is restricted by the minimum applicable temperature of the coil of -20°C.

The following **solenoid valves** are available:

Type	Function	Port size	Installation	Further information on valve on page
MH 311 015 VES Ex m	3/2-way direct acting	G 1/8"	in-line	2.12.4.1
MH 310 701 VES Ex m	3/2-way, single sol.	G 1/4" - 1/4" NPT	in-line	2.12.4.2
MOH 310 701 VES Ex m	3/2-way, n.o. single sol.	G 1/4" - 1/4" NPT	in-line	2.12.4.2
MH 310 121 VES Ex m	3/2-way, single sol.	G 1/2" - 1/2" NPT	in-line	2.12.4.3
MH 320 121 VES Ex m	3/2-way, double sol.	G 1/2"	in-line	2.12.4.3
MH 510 701 VES Ex m	5/2-way, single sol.	G 1/4" - 1/4" NPT	in-line	2.12.4.4
MH 510 121 VES Ex m	5/2-way, single sol.	G 1/2" - 1/2" NPT	in-line	2.12.4.4
MH 520 701 VES Ex m	5/2-way, double sol.	G 1/4" - 1/4" NPT	in-line	2.12.4.5
MH 520 121 VES Ex m	5/2-way, double sol.	G 1/2" - 1/2" NPT	in-line	2.12.4.5
MH 53_ 701 VES Ex m	5/3-way, different versions	G 1/4" - 1/4" NPT	in-line	2.12.4.6
MH 53_ 121 VES Ex m	5/3-way, different versions	G 1/2" - 1/2" NPT	in-line	2.12.4.6

Valves with interface according to NAMUR-standard				
MNH 350 701 VES Ex m	3/2-way & 5/2-way	G 1/4" - 1/4" NPT	1/4" NAMUR	2.12.5.3
MNH 310 701 VES Ex m	3/2-way, single sol.	G 1/4" - 1/4" NPT	1/4" NAMUR	2.12.5.1
MNH 510 701 VES Ex m	5/2-way, single sol.	G 1/4" - 1/4" NPT	1/4" NAMUR	2.12.5.2
MNH 520 701 VES Ex m	5/2-way, double sol.	G 1/4" - 1/4" NPT	1/4" NAMUR	2.12.5.2

Solenoids are described on page 2.14.3.2.4.

Delivery contains valve with the appropriate operator system, coil, manual and declaration of conformity.

MA 36 EEx m II T4 CSA FM

CSA / FM approved encapsulated coils for gas and dust explosion-hazardous environment with 60 cm flying leads.

Voltage:	Delivery on request: 12VDC, 24VDC, 110VAC, 220VAC, 240VAC
Voltage tolerance:	- 10...+ 10%
Relative duty cycle:	100 %
Temperature range:	-20°C ... +60°C
Protection according to EN 60529:	IP 65
Material solenoid coil:	Thermoplasticpolyester
Coil rating according to DIN VDE 0580:	Class H
Conduit:	1/2" NPT

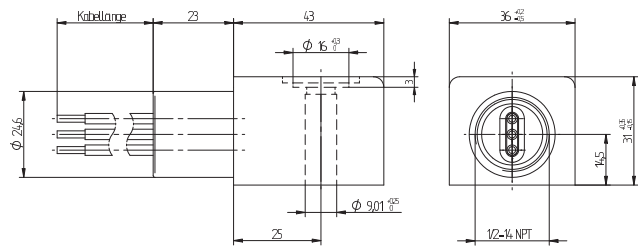

MA 36 EEx m II T4 CSA FM

As the coil is 36 mm wide, a spacer plate called "ZPN 8" has to be used, in case of combination with our NAMUR-valve series 700. If used with NAMUR-valve series 121 a spacer plate called "ZPN 6-5" has to be used. You can find both plates on page 2.10.16.

CSA/FM approval is only valid as long as the associated components are used.

Please note:
The coil is not approved according to ATEX.

Hazardous Locations:

Ex m II T4 and Division 1

Specifications in accordance to CSA certificate:

Class I, Division 1, Groups A, B, C and D; Class II, Groups E, F and G; Class III
Class I, Division 2, Groups A, B, C, D.

Specifications in accordance to FM certificate:

Explosion-proof Class I, Division 1, Groups A, B, C, D, T4, Ta = 60 °C
encapsulation/explosion-proof Class I, Zone 1, AEx m II T4, Ta = 60 °C
dust-ignition-proof for Class II/III, Division 1, Groups E, F and G, T4, Ta = 60 °C
Nonincendive Class I, Division 2, Groups A, B, C, D, T4, Ta = 60 °C
Suitable for Class II, III, Division 2, Groups E, F, G, T4, Ta = 60 °C

The current standards can be found in the certificates.

Type	Voltage	Operating press.	Power cons.	Temperature class
MA 36 EEx M II T4 CSA FM 12DC	12 V=	max. 10 bar	4,5 Watt	T4 (135° C)
MA 36 EEx M II T4 CSA FM 24DC	24 V=	max. 10 bar	4,6 Watt	T4 (135° C)
MA 36 EEx M II T4 CSA FM 110AC	110 V~	max. 10 bar	6,8 VA	T4 (135° C)
MA 36 EEx M II T4 CSA FM 220AC	220 V~	max. 10 bar	7,7 VA	T4 (135° C)
MA 36 EEx M II T4 CSA FM 240AC	240 V~	max. 10 bar	7,7 VA	T4 (135° C)

When this solenoid system is used in combination with „ATEX certified“ mechanical components conforming EN 13463-1:2001 and PrEN 13463-5:2000, the entire valve can be used in explosive hazardous environment zone 1, 2, 21 and 22.

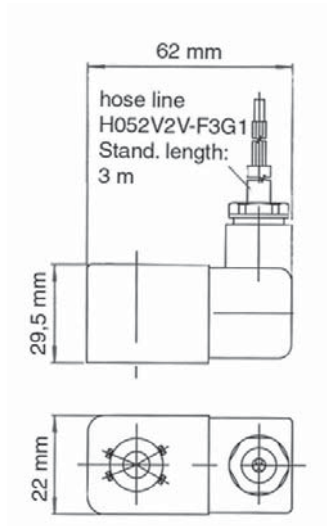

MA 22 EEx m II T4



ATEX approved encapsulated coils for gas and dust explosion-hazardous environment.

System is also IEC-Ex approved.

The standard cable length is 3 meter, others on request.

Voltage tolerance: -10...+10 %

Relative duty cycle: 100 %

Temperature range: -20°...+50° C

Insulation class of insulating materials according to DIN VDE 0580: F

Protection with mounted plug-in connector according to IEC 529: IP 65

Moulding material: Thermoplasticpolyester

Marking on coil:   II 2G Ex mb IIC T4 Gb
II 2D Ex mb tb IIIC T130°C Db

The ATEX approval is only valid as long as the associated components are used.

Type	Operating press.	Power consumption	Temperature class
MA 22 EEx M II T4 24DC	max. 10 bar	5,0 Watt	T4 (135° C)
MA 22 EEx M II T4 110AC	max. 10 bar	4,5 VA	T4 (135° C)
MA 22 EEx M II T4 230AC	max. 10 bar	5,1 VA	T4 (135° C)

ATEX-approved valves – Ex ia – standard temperature range – aluminum

The following solenoid valves are available:



Material: Aluminum, anodized
 Zone: 1, 2, 21, 22
 Temperature range: -10°C ... +50°C
 Ignition protection type: Ex ia (intrinsically safe)
 Temperature class: T6

Marking on valve

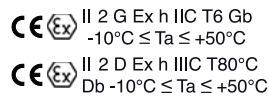

Please note:
 Maximum operating pressure for valves with Ex ia solenoid system is 8 bar!

Coil is 30 mm wide!

Solenoids are described on page 2.14.3.3.5.

Delivery contains valve with the appropriate operator system, coil, connector, manual and declaration of conformity.

Type	Function	Port size	Installation	Further inform. on valve on page
MH 210 501 Ex ia	2/2-way, single sol.	G 1/8"	in-line	2.5.1.1.13
MH 210 701 Ex ia	2/2-way, single sol.	G 1/4"	in-line	2.5.1.1.13
MH 311 012 Ex ia	3/2-way direct acting	M5	in-line	2.5.1.1.2
MH 311 015 Ex ia	3/2-way direct acting	G 1/8"	in-line	2.5.1.1.2
MH 310 501 Ex ia	3/2-way, single sol.	G 1/8"	in-line	2.5.1.1.14
MOH 310 501 Ex ia	3/2-way, n.o. single sol.	G 1/8"	in-line	2.5.1.1.14
MH 310 701 Ex ia	3/2-way, single sol.	G 1/4" - 1/4" NPT	in-line	2.5.1.1.14
MOH 310 701 Ex ia	3/2-way, n.o. single sol.	G 1/4" - 1/4" NPT	in-line	2.5.1.1.14
MH 310 801 Ex ia	3/2-way, single sol.	G 1/4"	in-line	2.5.1.1.14
MOH 310 801 Ex ia	3/2-way, n.o. single sol.	G 1/4"	in-line	2.5.1.1.14
MH 310 101 Ex ia	3/2-way, single sol.	G 3/8"	in-line	2.5.1.1.15
MOH 310 101 Ex ia	3/2-way, n.o. single sol.	G 3/8"	in-line	2.5.1.1.15
MH 310 121 Ex ia	3/2-way, single sol.	G 1/2" - 1/2" NPT	in-line	2.5.1.1.15
MOH 310 121 Ex ia	3/2-way, n.o. single sol.	G 1/2" - 1/2" NPT	in-line	2.5.1.1.15
MH 310 101 G Ex ia	3/2-way, single sol.	G 3/8"	dual use*	2.5.1.1.17
MOH 310 101 G Ex ia	3/2-way, n.o. single sol.	G 3/8"	dual use*	2.5.1.1.17
MH 310 121 G Ex ia	3/2-way, single sol.	G 1/2"	dual use*	2.5.1.1.17
MOH 310 121 G Ex ia	3/2-way, n.o. single sol.	G 1/2"	dual use*	2.5.1.1.17
MH 320 501 Ex ia	3/2-way, double sol.	G 1/8"	in-line	2.5.1.1.18
MH 320 701 Ex ia	3/2-way, double sol.	G 1/4"	in-line	2.5.1.1.18
MH 320 801 Ex ia	3/2-way, double sol.	G 1/4"	in-line	2.5.1.1.18
MH 320 101 Ex ia	3/2-way, double sol.	G 3/8"	in-line	2.5.1.1.19
MH 320 121 Ex ia	3/2-way, double sol.	G 1/2" - 1/2" NPT	in-line	2.5.1.1.19
MH 320 121 G Ex ia	3/2-way, double sol.	G 1/2"	dual use*	2.5.1.1.20
MH 510 501 Ex ia	5/2-way, single sol.	G 1/8"	in-line	2.5.2.1.3
MH 510 701 Ex ia	5/2-way, single sol.	G 1/4" - 1/4" NPT	in-line	2.5.2.1.3
MH 510 801 Ex ia	5/2-way, single sol.	G 1/4"	in-line	2.5.2.1.3
MH 510 101 Ex ia	5/2-way, single sol.	G 3/8"	in-line	2.5.2.1.4
MH 510 121 Ex ia	5/2-way, single sol.	G 1/2" - 1/2" NPT	in-line	2.5.2.1.4
MH 510 101 G Ex ia	5/2-way, single sol.	G 3/8"	dual use*	2.5.2.1.6
MH 510 121 G Ex ia	5/2-way, single sol.	G 1/2"	dual use*	2.5.2.1.6
MH 520 501 Ex ia	5/2-way, double sol.	G 1/8"	in-line	2.5.2.1.9
MH 520 701 Ex ia	5/2-way, double sol.	G 1/4" - 1/4" NPT	in-line	2.5.2.1.9
MH 520 801 Ex ia	5/2-way, double sol.	G 1/4"	in-line	2.5.2.1.9
MH 520 101 Ex ia	5/2-way, double sol.	G 3/8"	in-line	2.5.2.1.10
MH 520 121 Ex ia	5/2-way, double sol.	G 1/2" - 1/2" NPT	in-line	2.5.2.1.10
MH 520 101 G Ex ia	5/2-way, double sol.	G 3/8"	dual use*	2.5.2.1.12
MH 520 121 G Ex ia	5/2-way, double sol.	G 1/2"	dual use*	2.5.2.1.12
MH 53_ 501 Ex ia	5/3-way, different versions	G 1/8"	in-line	2.5.3.1.2
MH 53_ 701 Ex ia	5/3-way, different versions	G 1/4" - 1/4" NPT	in-line	2.5.3.1.2
MH 53_ 801 Ex ia	5/3-way, different versions	G 1/4"	in-line	2.5.3.1.2
MH 53_ 101 Ex ia	5/3-way, different versions	G 3/8"	in-line	2.5.3.1.3
MH 53_ 121 Ex ia	5/3-way, different versions	G 1/2" - 1/2" NPT	in-line	2.5.3.1.3
MH 53_ 101 G Ex ia	5/3-way, different versions	G 3/8"	dual use*	2.5.3.1.5
MH 53_ 121 G Ex ia	5/3-way, different versions	G 1/2"	dual use*	2.5.3.1.5

Valves with interface according to NAMUR-standard

MNH 350 701 Ex ia	3/2-way & 5/2-way	G 1/4" - 1/4" NPT	1/4" NAMUR 2.9.1.3
MNH 310 701 Ex ia	3/2-way, single sol.	G 1/4" - 1/4" NPT	1/4" NAMUR 2.9.1.1.1
MNH 310 711 Ex ia	3/2-way, single sol.	G 1/4"	1/4" NAMUR 2.9.1.1.1
MNH 310 121 Ex ia	3/2-way, single sol.	G 1/2" - 1/2" NPT	1/2" NAMUR 2.9.1.1.2
MNH 510 701 Ex ia	5/2-way, single sol.	G 1/4" - 1/4" NPT	1/4" NAMUR 2.9.1.2.1
MNH 510 711 Ex ia	5/2-way, single sol.	G 1/4"	1/4" NAMUR 2.9.1.2.1
MNH 510 121 Ex ia	5/2-way, single sol.	G 1/2" - 1/2" NPT	1/2" NAMUR 2.9.1.2.2
MNH 520 701 Ex ia	5/2-way, double sol.	G 1/4" - 1/4" NPT	1/4" NAMUR 2.9.1.2.3
MNH 520 121 Ex ia	5/2-way, double sol.	G 1/2" - 1/2" NPT	1/2" NAMUR 2.9.1.2.3
MNH 53_ 701 Ex ia	5/3-way, different versions	G 1/4" - 1/4" NPT	1/4" NAMUR 2.9.1.4
MNH 53_ 121 Ex ia	5/3-way, centre closed	G 1/2" - 1/2" NPT	1/2" NAMUR 2.9.1.4

* dual use valves can either be used in-line or on a manifold plate.

ATEX-approved valves – Ex ia – low temperature range – aluminum



Material: Aluminum, anodized
 Zone: 1, 2, 21, 22
 Temperature range: -40°C ... +50°C ❄️
 Ignition protection type: Ex ia (intrinsically safe)
 Temperature class: T6

Marking on valve

 II 2 G Ex h IIC T6 Gb
 -40°C ≤ Ta ≤ +50°C

 II 2 D Ex h IIIC T80°C
 Db -40°C ≤ Ta ≤ +50°C

Please note:
 Maximum operating pressure for valves with Ex ia solenoid system is 8 bar!

Coil is 30 mm wide!

The following solenoid valves are available:

Type	Function	Port size	Installation	Further information on valve on page
MH 311 012 TT Ex ia	3/2-way direct acting	M5	in-line	2.11.5.1.1
MH 311 015 TT Ex ia	3/2-way direct acting	G 1/8"	in-line	2.11.5.1.1
MH 310 501 TT Ex ia	3/2-way, single sol.	G 1/8"	in-line	2.11.5.1.2
MOH 310 501 TT Ex ia	3/2-way, n.o. single sol.	G 1/8"	in-line	2.11.5.1.2
MH 310 701 GTT Ex ia	3/2-way, single sol.	G 1/4" - 1/4" NPT	dual use*	2.11.5.1.2
MOH 310 701 GTT Ex ia	3/2-way, n.o. single sol.	G 1/4" - 1/4" NPT	dual use*	2.11.5.1.2
MH 320 501 TT Ex ia	3/2-way, double sol.	G 1/8"	in-line	2.11.5.1.2
MH 320 701 GTT Ex ia	3/2-way, double sol.	G 1/4"	dual use*	2.11.5.1.2
MH 510 501 GTT Ex ia	5/2-way, single sol.	G 1/8"	dual use*	2.11.5.2.1
MH 510 701 GTT Ex ia	5/2-way, single sol.	G 1/4" - 1/4" NPT	dual use*	2.11.5.2.1
MH 520 501 GTT Ex ia	5/2-way, double sol.	G 1/8"	dual use*	2.11.5.2.2
MH 520 701 GTT Ex ia	5/2-way, double sol.	G 1/4" - 1/4" NPT	dual use*	2.11.5.2.2
MH 53_ 501 GTT Ex ia	5/3-way, different versions	G 1/8"	dual use*	2.11.5.2.2
MH 53_ 701 GTT Ex ia	5/3-way, different versions	G 1/4" - 1/4" NPT	dual use*	2.11.5.2.2

Valves with interface according to NAMUR-standard

MNH 310 701 TT Ex ia	3/2-way, single sol.	G 1/4" - 1/4" NPT	1/4" NAMUR	2.11.6.1
MNH 510 701 TT Ex ia	5/2-way, single sol.	G 1/4" - 1/4" NPT	1/4" NAMUR	2.11.6.2.1
MNH 510 711 TT Ex ia	5/2-way, single sol.	G 1/4"	1/4" NAMUR	2.11.6.2.1
MNH 520 701 TT Ex ia	5/2-way, double sol.	G 1/4" - 1/4" NPT	1/4" NAMUR	2.11.6.2.2
MNH 531 701 TT Ex ia	5/3-way, centre closed	G 1/4" - 1/4" NPT	1/4" NAMUR	2.11.6.2.2

* dual use valves can either be used in-line or on a manifold plate.



Solenoids are described on page 2.14.3.3.5.
 Delivery contains valve with the appropriate operator system, coil, manual and declaration of conformity.

ATEX-approved valves – Ex ia – standard temperature range – stainless steel

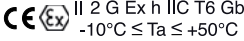

Material: Stainless steel, 316L 
 Zone: 1, 2, 21, 22
 Temperature range: -10°C ... +50°C
 Ignition protection type: Ex ia (intrinsically safe)
 Temperature class: T6

Marking on valve

Please note:
 Maximum operating pressure for valves with Ex ia solenoid system is 8 bar!

Coil is 30 mm wide!

The following solenoid valves are available:

Type	Function	Port size	Installation	Further information on valve on page
MH 311 015 VES Ex ia	3/2-way direct acting	G 1/8"	in-line	2.12.4.1
MH 310 701 VES Ex ia	3/2-way, single sol.	G 1/4" - 1/4" NPT	in-line	2.12.4.2
MOH 310 701 VES Ex ia	3/2-way, n.o. single sol.	G 1/4" - 1/4" NPT	in-line	2.12.4.2
MH 310 121 VES Ex ia	3/2-way, single sol.	G 1/2"	in-line	2.12.4.3
MH 320 121 VES Ex ia	3/2-way, double sol.	G 1/2"	in-line	2.12.4.3
MH 510 701 VES Ex ia	5/2-way, single sol.	G 1/4" - 1/4" NPT	in-line	2.12.4.4
MH 510 121 VES Ex ia	5/2-way, single sol.	G 1/2" - 1/2" NPT	in-line	2.12.4.4
MH 520 701 VES Ex ia	5/2-way, double sol.	G 1/4" - 1/4" NPT	in-line	2.12.4.5
MH 520 121 VES Ex ia	5/2-way, double sol.	G 1/2" - 1/2" NPT	in-line	2.12.4.5
MH 53_701 VES Ex ia	5/3-way, different versions	G 1/4" - 1/4" NPT	in-line	2.12.4.6
MH 53_121 VES Ex ia	5/3-way, different versions	G 1/2" - 1/2" NPT	in-line	2.12.4.6

Valves with interface according to NAMUR-standard



MNH 350 701 VES Ex ia	3/2-way & 5/2-way	G 1/4" - 1/4" NPT	1/4" NAMUR	2.12.5.3
MNH 310 701 VES Ex ia	3/2-way, single sol.	G 1/4" - 1/4" NPT	1/4" NAMUR	2.12.5.1
MNH 510 701 VES Ex ia	5/2-way, single sol.	G 1/4" - 1/4" NPT	1/4" NAMUR	2.12.5.2
MNH 520 701 VES Ex ia	5/2-way, double sol.	G 1/4" - 1/4" NPT	1/4" NAMUR	2.12.5.2

Solenoids are described on page 2.14.3.3.5.

Delivery contains valve with the appropriate operator system, coil, manual and declaration of conformity.

ATEX-approved valves – Ex ia – low temperature range – stainless steel



Material: Stainless steel, 316L 
 Zone: 1, 2, 21, 22
 Temperature range: -40°C ... +50°C 
 Ignition protection type: Ex ia (intrinsically safe)
 Temperature class: T6

Marking on valve   II 2 G Ex h IIC T6 Gb
 -40°C ≤ Ta ≤ +50°C
  II 2 D Ex h IIC T80°C
 Db -40°C ≤ Ta ≤ +50°C

Please note:
 Maximum operating pressure for valves with Ex ia solenoid system is 8 bar!

Coil is 30 mm wide!

The following solenoid valves are available:

Type	Function	Port size	Installation	Further information on valve on page
MH 311 015 VES TT Ex ia	3/2-way direct acting	G 1/8"	in-line	2.12.4.1
MH 310 701 VES TT Ex ia	3/2-way, single sol.	G 1/4" - 1/4" NPT	in-line	2.12.4.2
MOH 310 701 VES TT Ex ia	3/2-way, n.o. single sol.	G 1/4" - 1/4" NPT	in-line	2.12.4.2
MH 510 701 VES TT Ex ia	5/2-way, single sol.	G 1/4" - 1/4" NPT	in-line	2.12.4.4
MH 520 701 VES TT Ex ia	5/2-way, double sol.	G 1/4" - 1/4" NPT	in-line	2.12.4.5
MH 53_701 VES TT Ex ia	5/3-way, different versions	G 1/4" - 1/4" NPT	in-line	2.12.4.6

Valves with interface according to NAMUR-standard				
Type	Function	Port size	Installation	Further information on valve on page
MNH 350 701 VES TT Ex ia	3/2-way & 5/2-way	G 1/4" - 1/4" NPT	1/4" NAMUR	2.12.5.3
MNH 310 701 VES TT Ex ia	3/2-way, single sol.	G 1/4" - 1/4" NPT	1/4" NAMUR	2.12.5.1
MNH 510 701 VES TT Ex ia	5/2-way, single sol.	G 1/4" - 1/4" NPT	1/4" NAMUR	2.12.5.2
MNH 520 701 VES TT Ex ia	5/2-way, double sol.	G 1/4" - 1/4" NPT	1/4" NAMUR	2.12.5.2

Solenoids are described on page 2.14.3.3.5.

Delivery contains valve with the appropriate operator system, coil, manual and declaration of conformity.

MA 30 EEx ia tD II CT6 24DC



When this solenoid system is used in combination with „ATEX certified“ mechanical components conforming EN 13463-1:2001 and PrEN 13463-5:2000, the entire valve can be used in explosive hazardous environment zone 1, 2, 21, and 22.

ATEX approved intrinsic safety coil and connector for gas and dust explosion-hazardous environment. System is also IEC-Ex approved. Electrical connection according to DIN EN 175301-803-A / ISO 4400.

Coil:

Electrical characteristics: 21,6... 28 V DC
>37 mA
final temperature rise
18 K
275 Ohm +/-8 %

Relative duty cycle: 100 %

Temperature range: -40° ... +50° C

Insulation class of insulating materials according to DIN VDE 0580: F

Protection level with connector according to EN 60529: IP 65

Moulding material: Thermoset resin (Epoxy)

Marking on coil: II 2G Ex ia IIB/IIC T6
II 2D Ex tb IIIC T80°C

Barrier:

Electrical characteristics: 21,6... 28 V DC
Admissible peak value: 28 V DC
115 mA
1,6 W

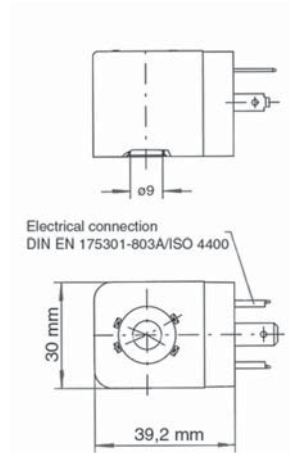

MA 30 EEx ia tD II CT6 24DC

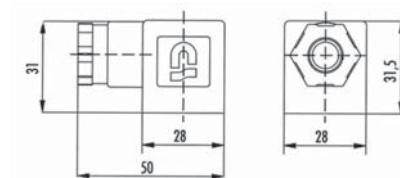

ST 30 Ex ia

Order Code: MA 30 EEx ia tD II CT6 24DC

As the coil is 30 mm wide, a spacer plate called „ZPN 5“ has to be used, in case of combination with our NAMUR-valve series 700 refer to page 2.10.12.

ST 30 Ex ia is an ATEX approved connector, especially designed for being used in combination with the intrinsic safety coil. For dust approval (zone 21), this original connector is mandatory. Delivery includes connector ST 30 Ex ia, flat nitril gasket and fixing screw (zinc-plated steel). Form according to A - ISO 4400, no LED, no varistor, operating voltage 0 – 250 V, max. current 10 A, cable diameter 6 – 8 mm.

How to select a suitable barrier:
I/U Characteristics supply units/solenoid coil

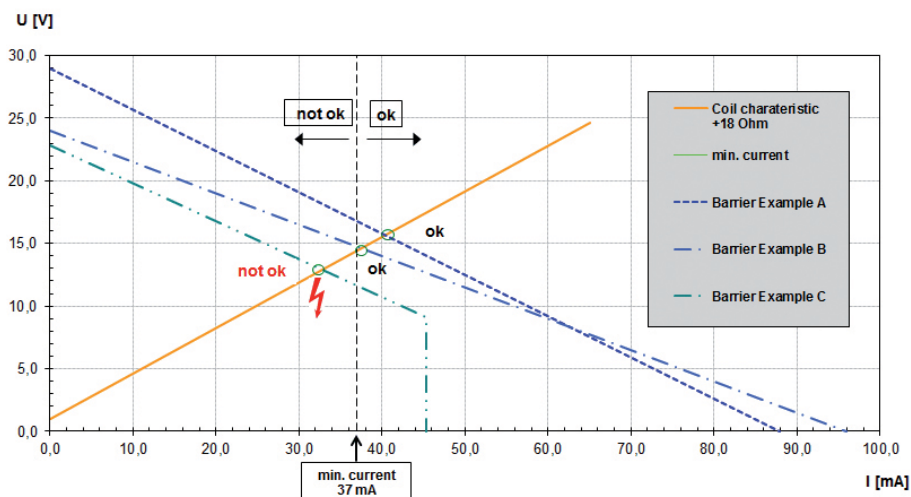

The ATEX approval is only valid as long as the associated components are used.

ATEX-approved valves – Ex nA and tc – standard temperature range – aluminum



Material: Aluminum, anodized, head PA
 Zone: 2, 22
 Temperature range: -10°C ... +50°C
 Ignition protection gas: Ex nA (non-sparking)
 Ignition protection dust: Ex t (protection using enclosure)**
 Temperature class: T5

Marking on valve

CE Ex II 3 G Ex h IIC T6 Gb
 -10°C ≤ Ta ≤ +50°C
 CE Ex II 3 D Ex h IIIC T80°C
 Db -10°C ≤ Ta ≤ +50°C

The following solenoid valves are available:

** only in combination with appropriate connector.

Type	Function	Port size	Installation	Further inform. on valve	Type	Function	Port size	Installation	Further inform. on valve
MH 210 501 Ex nA	2/2-way, single sol.	G 1/8"	in-line	2.5.1.1.13	MH 520 101 Ex nA	5/2-way, double sol.	G 3/8"	in-line	2.5.2.1.10
MH 210 701 Ex nA	2/2-way, single sol.	G 1/4"	in-line	2.5.1.1.13	MH 520 121 Ex nA	5/2-way, double sol.	G 1/2" - NPT	in-line	2.5.2.1.10
MH 311 012 Ex nA	3/2-way direct acting	M5	in-line	2.5.1.1.2	MH 520 501 G Ex nA	5/2-way, double sol.	G 1/8"	dual use*	2.5.2.1.11
MH 311 015 Ex nA	3/2-way direct acting	G 1/8"	in-line	2.5.1.1.2	MH 520 701 G Ex nA	5/2-way, double sol.	G 1/4" - NPT	dual use*	2.5.2.1.11
MH 311 013 Ex nA	3/2-way direct acting	G 1/8"	banjo screw	2.5.1.1.8	MH 520 101 G Ex nA	5/2-way, double sol.	G 3/8"	dual use*	2.5.2.1.12
MH 311 017 Ex nA	3/2-way direct acting	G 1/4"	banjo screw	2.5.1.1.8	MH 520 121 G Ex nA	5/2-way, double sol.	G 1/2"	dual use*	2.5.2.1.12
MH 312 Ex nA	3/2-way direct acting	M5	manifold	2.5.1.2.2	MH 520 504 Ex nA	5/2-way, double sol.	5 mm orifice	manifold	2.5.2.2.8
MH 315 Ex nA	3/2-way direct acting	G 1/8"	manifold	2.5.1.2.2	MH 520 704 Ex nA	5/2-way, double sol.	7 mm orifice	manifold	2.5.2.2.8
MH 310 501 Ex nA	3/2-way, single sol.	G 1/8"	in-line	2.5.1.1.14	MH 53_501 Ex nA	5/3-way, different versions	G 1/8"	in-line	2.5.3.1.2
MOH 310 501 Ex nA	3/2-way, n.o. single sol.	G 1/8"	in-line	2.5.1.1.14	MH 53_701 Ex nA	5/3-way, different versions	G 1/4"	in-line	2.5.3.1.2
MH 310 701 Ex nA	3/2-way, single sol.	G 1/4"	in-line	2.5.1.1.14	MH 53_801 Ex nA	5/3-way, different versions	G 1/4"	in-line	2.5.3.1.2
MOH 310 701 Ex nA	3/2-way, n.o. single sol.	G 1/4"	in-line	2.5.1.1.14	MH 53_101 Ex nA	5/3-way, different versions	G 3/8"	in-line	2.5.3.1.3
MH 310 801 Ex nA	3/2-way, single sol.	G 1/4"	in-line	2.5.1.1.14	MH 53_121 Ex nA	5/3-way, different versions	G 1/2" - NPT	in-line	2.5.3.1.3
MOH 310 801 Ex nA	3/2-way, n.o. single sol.	G 1/4"	in-line	2.5.1.1.14	MH 53_501 G Ex nA	5/3-way, different versions	G 1/8"	dual use*	2.5.3.1.4
MH 310 101 Ex nA	3/2-way, single sol.	G 3/8"	in-line	2.5.1.1.15	MH 53_701 G Ex nA	5/3-way, different versions	G 1/4" - NPT	dual use*	2.5.3.1.4
MOH 310 101 Ex nA	3/2-way, n.o. single sol.	G 3/8"	in-line	2.5.1.1.15	MH 53_101 G Ex nA	5/3-way, different versions	G 3/8"	dual use*	2.5.3.1.5
MH 310 121 Ex nA	3/2-way, single sol.	G 1/2" - NPT	in-line	2.5.1.1.15	MH 53_121 G Ex nA	5/3-way, different versions	G 1/2"	dual use*	2.5.3.1.5
MOH 310 121 Ex nA	3/2-way, n.o. single sol.	G 1/2" - NPT	in-line	2.5.1.1.15	MH 53_504 Ex nA	5/3-way, different versions	5 mm orifice	manifold	2.5.3.2.4
MH 310 501 G Ex nA	3/2-way, single sol.	G 1/8"	dual use*	2.5.1.1.16	MH 53_704 Ex nA	5/3-way, different versions	7 mm orifice	manifold	2.5.3.2.4
MOH 310 501 G Ex nA	3/2-way, n.o. single sol.	G 1/8"	dual use*	2.5.1.1.16					
MH 310 701 G Ex nA	3/2-way, single sol.	G 1/4" - NPT	dual use*	2.5.1.1.16					
MOH 310 701 G Ex nA	3/2-way, n.o. single sol.	G 1/4" - NPT	dual use*	2.5.1.1.16					
MH 310 101 G Ex nA	3/2-way, single sol.	G 3/8"	dual use*	2.5.1.1.17					
MOH 310 101 G Ex nA	3/2-way, n.o. single sol.	G 3/8"	dual use*	2.5.1.1.17					
MH 310 121 G Ex nA	3/2-way, single sol.	G 1/2"	dual use*	2.5.1.1.17					
MOH 310 121 G Ex nA	3/2-way, n.o. single sol.	G 1/2"	dual use*	2.5.1.1.17					
MH 320 501 Ex nA	3/2-way, double sol.	G 1/8"	in-line	2.5.1.1.18					
MH 320 701 Ex nA	3/2-way, double sol.	G 1/4"	in-line	2.5.1.1.18					
MH 320 801 Ex nA	3/2-way, double sol.	G 1/4"	in-line	2.5.1.1.18					
MH 320 101 Ex nA	3/2-way, double sol.	G 3/8"	in-line	2.5.1.1.19					
MH 320 121 Ex nA	3/2-way, double sol.	G 1/2"	in-line	2.5.1.1.19					
MH 320 501 G Ex nA	3/2-way, double sol.	G 1/8"	dual use*	2.5.1.1.20					
MH 320 701 G Ex nA	3/2-way, double sol.	G 1/4"	dual use*	2.5.1.1.20					
MH 320 101 G Ex nA	3/2-way, double sol.	G 3/8"	dual use*	2.5.1.1.20					
MH 320 121 G Ex nA	3/2-way, double sol.	G 1/2"	dual use*	2.5.1.1.20					
MH 510 501 Ex nA	5/2-way, single sol.	G 1/8"	in-line	2.5.2.1.3					
MH 510 701 Ex nA	5/2-way, single sol.	G 1/4"	in-line	2.5.2.1.3					
MH 510 801 Ex nA	5/2-way, single sol.	G 1/4"	in-line	2.5.2.1.3					
MH 510 101 Ex nA	5/2-way, single sol.	G 3/8"	in-line	2.5.2.1.4					
MH 510 121 Ex nA	5/2-way, single sol.	G 1/2" - NPT	in-line	2.5.2.1.4					
MH 510 501 G Ex nA	5/2-way, single sol.	G 1/8"	dual use*	2.5.2.1.5					
MH 510 701 G Ex nA	5/2-way, single sol.	G 1/4" - NPT	dual use*	2.5.2.1.5					
MH 510 101 G Ex nA	5/2-way, single sol.	G 3/8"	dual use*	2.5.2.1.6					
MH 510 121 G Ex nA	5/2-way, single sol.	G 1/2"	dual use*	2.5.2.1.6					
MH 510 504 Ex nA	5/2-way, single sol.	5 mm orifice	manifold	2.5.2.2.4					
MH 510 704 Ex nA	5/2-way, single sol.	7 mm orifice	manifold	2.5.2.2.4					
MH 520 501 Ex nA	5/2-way, double sol.	G 1/8"	in-line	2.5.2.1.9					
MH 520 701 Ex nA	5/2-way, double sol.	G 1/4"	in-line	2.5.2.1.9					
MH 520 801 Ex nA	5/2-way, double sol.	G 1/4"	in-line	2.5.2.1.9					

Valves with interface according to NAMUR-standard

MNH 350 701 Ex nA	3/2-way & 5/2-way	G 1/4" - NPT	1/4" NAMUR	2.9.1.3
MNH 310 701 Ex nA	3/2-way, single sol.	G 1/4" - NPT	1/4" NAMUR	2.9.1.1.1
MNH 310 711 Ex nA	3/2-way, single sol.	G 1/4"	1/4" NAMUR	2.9.1.1.1
MNH 310 121 Ex nA	3/2-way, single sol.	G 1/2" - NPT	1/2" NAMUR	2.9.1.1.2
MNH 510 701 Ex nA	5/2-way, single sol.	G 1/4" - NPT	1/4" NAMUR	2.9.1.2.1
MNH 510 711 Ex nA	5/2-way, single sol.	G 1/4"	1/4" NAMUR	2.9.1.2.1
MNH 510 121 Ex nA	5/2-way, single sol.	G 1/2" - NPT	1/2" NAMUR	2.9.1.2.2
MNH 520 701 Ex nA	5/2-way, double sol.	G 1/4" - NPT	1/4" NAMUR	2.9.1.2.3
MNH 520 121 Ex nA	5/2-way, double sol.	G 1/2" - NPT	1/2" NAMUR	2.9.1.2.3
MNH 53_701 Ex nA	5/3-way, different versions	G 1/4" - NPT	1/4" NAMUR	2.9.1.4
MNH 531 121 Ex nA	5/3-way, centre closed	G 1/2" - NPT	1/2" NAMUR	2.9.1.4



* dual use valves can either be used in-line or on a manifold plate.

Solenoids are described on page 2.14.3.4.3. Delivery contains valve with the appropriate operator system, coil, manual and declaration of conformity.

ATEX-approved valves – Ex nA and tc – standard temperature range – stainless steel



Material: Stainless steel, 316L 
 Zone: 2, 22
 Temperature range: -10°C ... +50°C
 Ignition protection gas: Ex nA (non-sparking)
 Ignition protection dust: Ex t (protection using enclosure)*
 Temperature class: T5

Marking on valve  II 3 G Ex h IIC T6 Gb
 -10°C ≤ Ta ≤ +50°C
 II 3 D Ex h IIC T80°C
 Db -10°C ≤ Ta ≤ +50°C

* only in combination with appropriate connector.

The following solenoid valves are available:

Type	Function	Port size	Installation	Further information on valve on page
MH 311 015 VES Ex nA	3/2-way direct acting	G 1/8"	in-line	2.12.4.1
MH 310 701 VES Ex nA	3/2-way, single sol.	G 1/4" - 1/4" NPT	in-line	2.12.4.2
MOH 310 701 VES Ex nA	3/2-way, n.o. single sol.	G 1/4" - 1/4" NPT	in-line	2.12.4.2
MH 310 121 VES Ex nA	3/2-way, single sol.	G 1/2" - 1/2" NPT	in-line	2.12.4.3
MH 320 121 VES Ex nA	3/2-way, double sol.	G 1/2"	in-line	2.12.4.3
MH 510 701 VES Ex nA	5/2-way, single sol.	G 1/4" - 1/4" NPT	in-line	2.12.4.4
MH 510 121 VES Ex nA	5/2-way, single sol.	G 1/2" - 1/2" NPT	in-line	2.12.4.4
MH 520 701 VES Ex nA	5/2-way, double sol.	G 1/4" - 1/4" NPT	in-line	2.12.4.5
MH 520 121 VES Ex nA	5/2-way, double sol.	G 1/2" - 1/2" NPT	in-line	2.12.4.5
MH 53_ 701 VES Ex nA	5/3-way, different versions	G 1/4" - 1/4" NPT	in-line	2.12.4.6
MH 53_ 121 VES Ex nA	5/3-way, different versions	G 1/2" - 1/2" NPT	in-line	2.12.4.6

Valves with interface according to NAMUR-standard

MNH 350 701 VES Ex nA	3/2-way & 5/2-way	G 1/4" - 1/4" NPT	1/4" NAMUR	2.12.5.3
MNH 310 701 VES Ex nA	3/2-way, single sol.	G 1/4" - 1/4" NPT	1/4" NAMUR	2.12.5.1
MNH 510 701 VES Ex nA	5/2-way, single sol.	G 1/4" - 1/4" NPT	1/4" NAMUR	2.12.5.2
MNH 520 701 VES Ex nA	5/2-way, double sol.	G 1/4" - 1/4" NPT	1/4" NAMUR	2.12.5.2

Solenoids are described on page 2.14.3.4.3.

Delivery contains valve with the appropriate operator system, coil, manual and declaration of conformity.

When this solenoid system is used in combination with "ATEX certified" mechanical components conforming EN 13463-1:2001 and PrEN 13463-5:2000, the entire valve can be used in explosive hazardous environment zone 2 and 22.

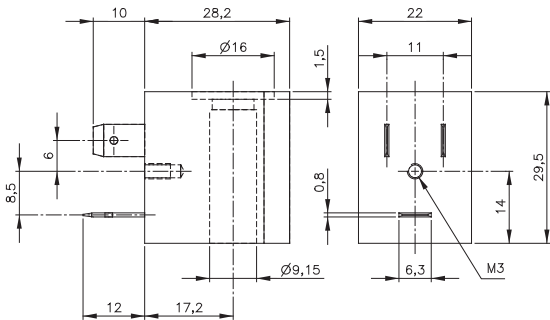

MA 22 EEx nA T5 24DC

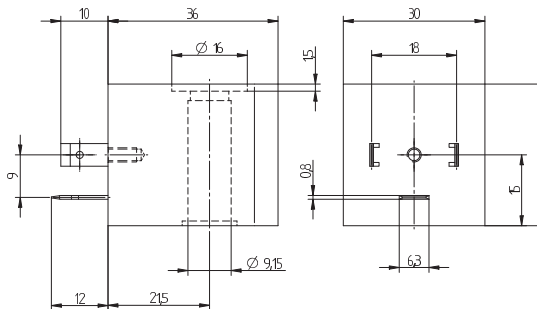

MA 30 EEx nA T6 24DC



ATEX approved coil for gas (non-sparking) and dust (protection using enclosure) explosion-hazardous environment.

Coil:

Voltage tolerance: 24 V DC +/- 10 %

Relative duty cycle: 100 %

Temperature range: -15° ... +50° C

Insulation class of insulating materials according to DIN VDE 0580: F

Protection with connector according to EN 60529: IP 65

Moulding material: Termoplasticpolyester

Marking on coil:

T5:   II 3G Ex nA IIC T5 Gc
II 3D Ex tc IIIC 95°C Dc

T6:   II 3G Ex nA IIC T6 Gc
II 3D Ex tc IIIC 80°C Dc

Delivery content without ATEX approved connector.

30 mm wide ATEX connector available, type ST 30 Ex nA.
22 mm wide ATEX connector available, type ST 22 Ex.
Please refer to page 2.14.5.1.

The ATEX approval is only valid as long as the associated components are used.

Type	Operating press.	Power cons.	Temp. class	Connection
MA 22 EEx nA T5 24DC	max. 10 bar	3,0 Watt	T5 (100° C)	Industry form B (DW 436 50)
MA 30 EEx nA T6 24DC	max. 10 bar	2,0 Watt	T6 (85° C)	Form A (ISO 4400)

Other voltages are available on request.

ATEX-approved valves – Ex e mb – standard temperature range – aluminum



Material: Aluminum, anodized
 Zone: 1, 2, 21, 22
 Temperature range: -10°C ... +50°C
 Ignition protection type: Ex e mb (encapsulation with junction box)
 Temperature class: T6

Marking on valve

CE Ex II 2 G Ex h IIC T6 Gb
 -10°C ≤ Ta ≤ +50°C
 CE Ex II 2 D Ex h IIIC T80°C
 Db -10°C ≤ Ta ≤ +50°C

The following solenoid valves are available:

Type	Function	Port size	Installation	Further information on valve on page
MH 310 501 Ex e mb	3/2-way, single sol.	G 1/8"	in-line	2.5.1.1.14
MOH 310 501 Ex e mb	3/2-way, n.o. single sol.	G 1/8"	in-line	2.5.1.1.14
MH 310 701 Ex e mb	3/2-way, single sol.	G 1/4" - 1/4" NPT	in-line	2.5.1.1.14
MOH 310 701 Ex e mb	3/2-way, n.o. single sol.	G 1/4" - 1/4" NPT	in-line	2.5.1.1.14
MH 310 801 Ex e mb	3/2-way, single sol.	G 1/4"	in-line	2.5.1.1.14
MOH 310 801 Ex e mb	3/2-way, n.o. single sol.	G 1/4"	in-line	2.5.1.1.14
MH 310 101 Ex e mb	3/2-way, single sol.	G 3/8"	in-line	2.5.1.1.15
MOH 310 101 Ex e mb	3/2-way, n.o. single sol.	G 3/8"	in-line	2.5.1.1.15
MH 310 121 Ex e mb	3/2-way, single sol.	G 1/2" - 1/2" NPT	in-line	2.5.1.1.15
MOH 310 121 Ex e mb	3/2-way, n.o. single sol.	G 1/2" - 1/2" NPT	in-line	2.5.1.1.15
MH 320 501 Ex e mb	3/2-way, double sol.	G 1/8"	in-line	2.5.1.1.18
MH 320 701 Ex e mb	3/2-way, double sol.	G 1/4"	in-line	2.5.1.1.18
MH 320 801 Ex e mb	3/2-way, double sol.	G 1/4"	in-line	2.5.1.1.18
MH 320 101 Ex e mb	3/2-way, double sol.	G 3/8"	in-line	2.5.1.1.19
MH 320 121 Ex e mb	3/2-way, double sol.	G 1/2"	in-line	2.5.1.1.19
MH 510 501 Ex e mb	5/2-way, single sol.	G 1/8"	in-line	2.5.2.1.3
MH 510 701 Ex e mb	5/2-way, single sol.	G 1/4" - 1/4" NPT	in-line	2.5.2.1.3
MH 510 801 Ex e mb	5/2-way, single sol.	G 1/4"	in-line	2.5.2.1.3
MH 510 101 Ex e mb	5/2-way, single sol.	G 3/8"	in-line	2.5.2.1.4
MH 510 121 Ex e mb	5/2-way, single sol.	G 1/2" - 1/2" NPT	in-line	2.5.2.1.4
MH 520 501 Ex e mb	5/2-way, double sol.	G 1/8"	in-line	2.5.2.1.9
MH 520 701 Ex e mb	5/2-way, double sol.	G 1/4" - 1/4" NPT	in-line	2.5.2.1.9
MH 520 801 Ex e mb	5/2-way, double sol.	G 1/4"	in-line	2.5.2.1.9
MH 520 101 Ex e mb	5/2-way, double sol.	G 3/8"	in-line	2.5.2.1.10
MH 520 121 Ex e mb	5/2-way, double sol.	G 1/2" - 1/2" NPT	in-line	2.5.2.1.10
MH 53_501 Ex e mb	5/3-way, different versions	G 1/8"	in-line	2.5.3.1.2
MH 53_701 Ex e mb	5/3-way, different versions	G 1/4" - 1/4" NPT	in-line	2.5.3.1.2
MH 53_801 Ex e mb	5/3-way, different versions	G 1/4"	in-line	2.5.3.1.2
MH 53_101 Ex e mb	5/3-way, different versions	G 3/8"	in-line	2.5.3.1.3
MH 53_121 Ex e mb	5/3-way, different versions	G 1/2" - 1/2" NPT	in-line	2.5.3.1.3

Valves with interface according to NAMUR-standard

MNH 350 701 Ex e mb	3/2-way & 5/2-way	G 1/4" - 1/4" NPT	1/4" NAMUR	2.9.1.3
MNH 310 701 Ex e mb	3/2-way, single sol.	G 1/4" - 1/4" NPT	1/4" NAMUR	2.9.1.1.1
MNH 310 711 Ex e mb	3/2-way, single sol.	G 1/4"	1/4" NAMUR	2.9.1.1.1
MNH 310 121 Ex e mb	3/2-way, single sol.	G 1/2" - 1/2" NPT	1/2" NAMUR	2.9.1.1.2
MNH 510 701 Ex e mb	5/2-way, single sol.	G 1/4" - 1/4" NPT	1/4" NAMUR	2.9.1.2.1
MNH 510 711 Ex e mb	5/2-way, single sol.	G 1/4"	1/4" NAMUR	2.9.1.2.1
MNH 510 121 Ex e mb	5/2-way, single sol.	G 1/2" - 1/2" NPT	1/2" NAMUR	2.9.1.2.2
MNH 520 701 Ex e mb	5/2-way, double sol.	G 1/4" - 1/4" NPT	1/4" NAMUR	2.9.1.2.3
MNH 520 121 Ex e mb	5/2-way, double sol.	G 1/2" - 1/2" NPT	1/2" NAMUR	2.9.1.2.3
MNH 53_701 Ex e mb	5/3-way, different versions	G 1/4" - 1/4" NPT	1/4" NAMUR	2.9.1.4
MNH 531 121 Ex e mb	5/3-way, centre closed	G 1/2" - 1/2" NPT	1/2" NAMUR	2.9.1.4

Solenoids are described on page 2.14.3.5.4.

Example drawings including the solenoid are displayed on page 2.14.3.5.5.

Delivery contains valve with the appropriate operator system, coil, manual and declaration of conformity.

ATEX-approved valves – Ex e mb – low temperature range – aluminum



Material: Aluminum, anodized
 Zone: 1, 2, 21, 22
 Temperature range: -40°C ... +50°C ❄️
 Ignition protection type: Ex e mb (encapsulation with junction box)
 Temperature class: T6

Marking on valve

 II 2 G Ex h IIC T6 Gb
 -40°C ≤ Ta ≤ +50°C

 II 2 D Ex h IIC T80°C
 Db -40°C ≤ Ta ≤ +50°C

The following solenoid valves are available:

Type	Function	Port size	Installation	Further information on valve on page
MH 310 501 TT Ex e mb	3/2-way, single sol.	G 1/8"	in-line	2.11.5.1.2
MOH 310 501 TT Ex e mb	3/2-way, n.o. single sol.	G 1/8"	in-line	2.11.5.1.2
MH 310 701 GTT Ex e mb	3/2-way, single sol.	G 1/4" - 1/4" NPT	in-line	2.11.5.1.2
MOH 310 701 GTT Ex e mb	3/2-way, n.o. single sol.	G 1/4" - 1/4" NPT	in-line	2.11.5.1.2
MH 320 501 TT Ex e mb	3/2-way, double sol.	G 1/8"	in-line	2.11.5.1.2
MH 320 701 TT Ex e mb	3/2-way, double sol.	G 1/4"	in-line	2.11.5.1.2
MH 510 501 GTT Ex e mb	5/2-way, single sol.	G 1/8"	in-line	2.11.5.2.1
MH 510 701 GTT Ex e mb	5/2-way, single sol.	G 1/4" - 1/4" NPT	in-line	2.11.5.2.1
MH 520 501 GTT Ex e mb	5/2-way, double sol.	G 1/8"	in-line	2.11.5.2.2
MH 520 701 GTT Ex e mb	5/2-way, double sol.	G 1/4" - 1/4" NPT	in-line	2.11.5.2.2
MH 53_ 501 GTT Ex e mb	5/3-way, different versions	G 1/8"	in-line	2.11.5.2.2
MH 53_ 701 GTT Ex e mb	5/3-way, different versions	G 1/4" - 1/4" NPT	in-line	2.11.5.2.2

Valves with interface according to NAMUR-standard

MNH 310 701 TT Ex e mb	3/2-way, single sol.	G 1/4" - 1/4" NPT	1/4" NAMUR	2.11.6.1
MNH 510 701 TT Ex e mb	5/2-way, single sol.	G 1/4" - 1/4" NPT	1/4" NAMUR	2.11.6.2.1
MNH 510 711 TT Ex e mb	5/2-way, single sol.	G 1/4"	1/4" NAMUR	2.11.6.2.1
MNH 520 701 TT Ex e mb	5/2-way, double sol.	G 1/4" - 1/4" NPT	1/4" NAMUR	2.11.6.2.2
MNH 531 701 TT Ex e mb	5/3-way, centre closed	G 1/4" - 1/4" NPT	1/4" NAMUR	2.11.6.2.2



Solenoids are described on page 2.14.3.5.4.

Example drawings including the solenoid are displayed on page 2.14.3.5.5.





Delivery contains valve with the appropriate operator system, coil, manual and declaration of conformity.

ATEX-approved valves – Ex e mb – low temperature range – stainless steel



Material: Stainless steel, 316L 
 Zone: 1, 2, 21, 22
 Temperature range: -40°C ... +50°C 
 Ignition protection type: Ex e mb (encapsulation with junction box)
 Temperature class: T6

Marking on valve

  II 2 G Ex h IIC T6 Gb
 -40°C ≤ Ta ≤ +50°C
  II 2 D Ex h IIIIC T80°C
 Db -40°C ≤ Ta ≤ +50°C

The following solenoid valves are available:

Type	Function	Port size	Installation	Further information on valve on page
MH 310 701 VES TT Ex e mb	3/2-way, single sol.	G 1/4" - 1/4" NPT	in-line	2.12.4.2
MOH 310 701 VES TT Ex e mb	3/2-way, n.o. single sol.	G 1/4" - 1/4" NPT	in-line	2.12.4.2
MH 510 701 VES TT Ex e mb	5/2-way, single sol.	G 1/4" - 1/4" NPT	in-line	2.12.4.4
MH 520 701 VES TT Ex e mb	5/2-way, double sol.	G 1/4" - 1/4" NPT	in-line	2.12.4.5
MH 53_701 VES TT Ex e mb	5/3-way, different version	G 1/4" - 1/4" NPT	in-line	2.12.4.6

Valves with interface according to NAMUR-standard

MNH 350 701 VES TT Ex e mb	3/2-way & 5/2-way	G 1/4" - 1/4" NPT	1/4" NAMUR	2.12.5.3
MNH 310 701 VES TT Ex e mb	3/2-way, single sol.	G 1/4" - 1/4" NPT	1/4" NAMUR	2.12.5.1
MNH 310 711 VES TT Ex e mb	3/2-way, single sol.	G 1/4"	1/4" NAMUR	2.12.5.1
MNH 510 701 VES TT Ex e mb	5/2-way, single sol.	G 1/4" - 1/4" NPT	1/4" NAMUR	2.12.5.2
MNH 510 711 VES TT Ex e mb	5/2-way, single sol.	G 1/4"	1/4" NAMUR	2.12.5.2
MNH 520 701 VES TT Ex e mb	5/2-way, double sol.	G 1/4" - 1/4" NPT	1/4" NAMUR	2.12.5.2

Solenoids are described on page 2.14.3.5.4.

Example drawings including the solenoid are displayed on page 2.14.3.5.5.

Delivery contains valve with the appropriate operator system, coil, manual and declaration of conformity.
 1/2" stainless steel valves in standard temperature range on request.

When this solenoid system is used in combination with "ATEX certified" mechanical components conforming EN 13463-1:2001 and PrEN 13463-5:2000, the entire valve can be used in explosive hazardous environment zone 1, 2, 21 and 22.

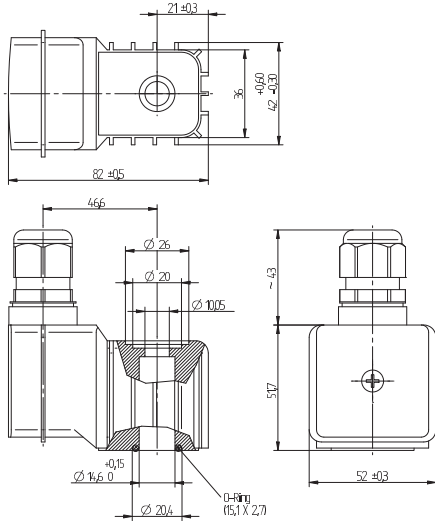

MA 52 EEx e mb IIC T6

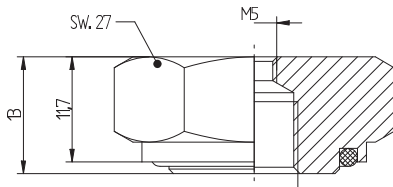

M G1/8 M5

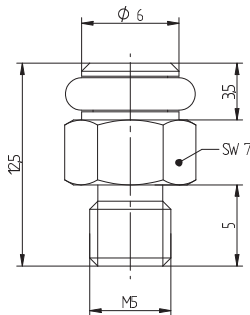

ESR M5



Details of junction box

ATEX approved encapsulated coil with junction box for gas and dust explosion-hazardous environment.

Voltage tolerance: - 10...+ 10%
Relative duty cycle: 100 %
Temperature range: -40°C...+50°C

Insulation class of insulating Materials according to DIN VDE 0580: F

Protection according to EN 60529: IP 65
(IP 67 with nut type M G1/8 M5 in combination with exhaust protection fitting type ESR M5)

Moulding material: Thermoplasticpolyester

Cable Gland: M20 x 1,5
for cable diameters 6 – 13 mm

Please note:
Same coil for DC and AC.

Marking on coil:  II 2G Ex e mb IIC T6 Gb
II 2D Ex tb mb IIC T80°C Db

The ATEX approval is only valid as long as the associated components are used.

Important installation instructions:
Connecting cables and connecting lines shall be suitable for permanent application in a temperature range of -40 °C up to +105 °C and must be laid fixed to the device. The user shall provide for a strain relief. When using silicone or silicone-containing cables for connection or cables that are not resistant to scoring, these shall be protected against mechanical damage. For further instructions, please ask us for the operating manual.

Type	Operating press.	Power cons.	Temperature class
MA 52 EEx e mb IIC T6 24	max. 10 bar	4,8 Watt	T6 (85° C)
MA 52 EEx e mb IIC T6 110	max. 10 bar	4,8 Watt	T6 (85° C)
MA 52 EEx e mb IIC T6 230	max. 10 bar	4,8 Watt	T6 (85° C)

Example drawings of solenoid valves with Ex e mb solenoid system

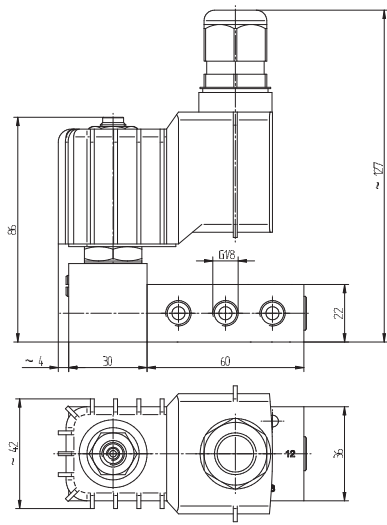

MH 510 501 Ex e mb IIC T6

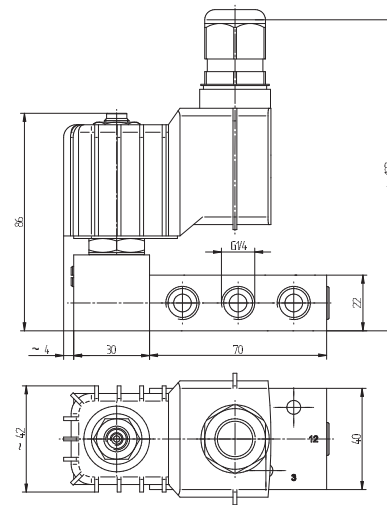
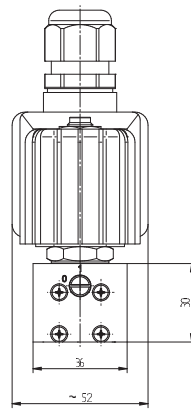

MH 510 701 Ex e mb IIC T6 /
MNH 510 701 EX e mb IIC T6

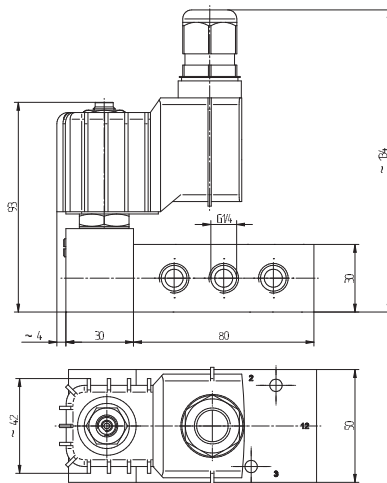
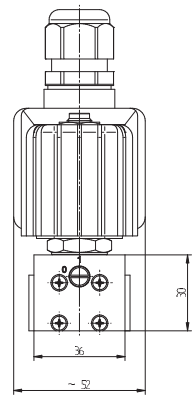

MH 510 801 Ex e mb IIC T6

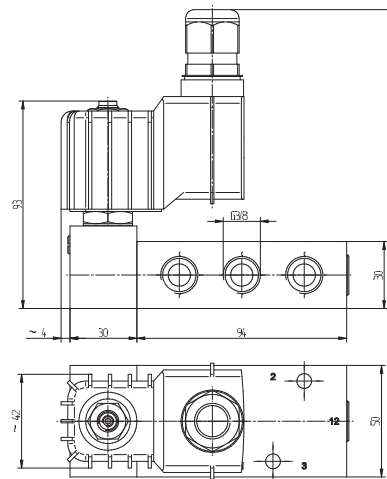
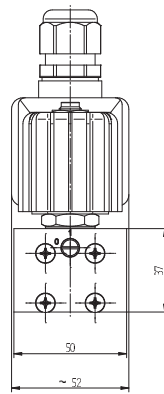

MH 510 101 Ex e mb IIC T6

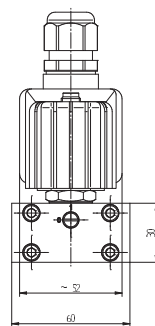
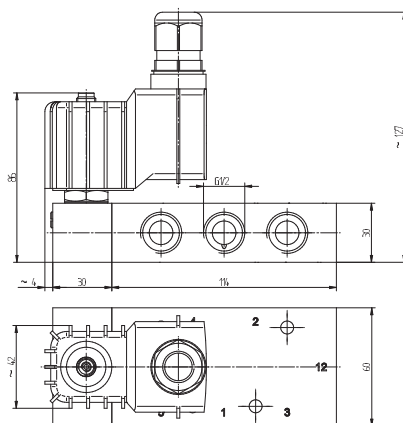
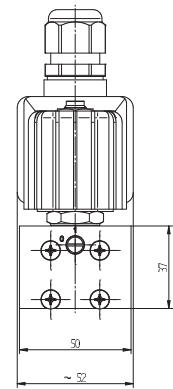

MH 510 121 Ex e mb IIC T6 /
MNH 510 121 Ex e mb IIC T6

ATEX-approved valves – Ex d – standard temperature range – aluminum



Interface between valve body and solenoid system according to CNOMO, therefore the types are called MC.

Base plate assembly due to solenoid coil is not possible.

Flameproof solenoids are displayed on page 2.14.3.6.5.

Example drawings including the solenoid are displayed on page 2.14.3.6.6.

Material: Aluminum, anodized
 Zone: 1, 2, 21, 22
 Temperature range: -10°C ... +50°C
 Solenoid coil limited to +40°C
 Ignition protection type: Ex d – flameproof
 Temperature class: T6 (solenoid)

Marking on valve

CE Ex II 2 G Ex h IIC T6 Gb
 -10°C ≤ Ta ≤ +50°C
 CE Ex II 2 D Ex h IIIC T80°C
 Db -10°C ≤ Ta ≤ +50°C

The following solenoid valves are available:

Type	Function	Port size	Installation	Further information on valve on page
MC 210 501 Ex d	2/2-way, single sol.	G 1/8"	in-line	2.5.1.1.13
MC 210 701 Ex d	2/2-way, single sol.	G 1/4"	in-line	2.5.1.1.13
MC 310 501 Ex d	3/2-way, single sol.	G 1/8"	in-line	2.5.1.1.14
MOC 310 501 Ex d	3/2-way, n.o. single sol.	G 1/8"	in-line	2.5.1.1.14
MC 310 701 Ex d	3/2-way, single sol.	G 1/4"	in-line	2.5.1.1.14
MOC 310 701 Ex d	3/2-way, n.o. single sol.	G 1/4"	in-line	2.5.1.1.14
MC 310 121 Ex d	3/2-way, single sol.	G 1/2"	in-line	2.5.1.1.15
MOC 310 121 Ex d	3/2-way, n.o. single sol.	G 1/2"	in-line	2.5.1.1.15
MC 320 501 Ex d	3/2-way, double sol.	G 1/8"	in-line	2.5.1.1.18
MC 320 701 Ex d	3/2-way, double sol.	G 1/4"	in-line	2.5.1.1.18
MC 320 121 Ex d	3/2-way, double sol.	G 1/2"	in-line	2.5.1.1.19
MC 510 501 Ex d	5/2-way, single sol.	G 1/8"	in-line	2.5.2.1.3
MC 510 701 Ex d	5/2-way, single sol.	G 1/4"	in-line	2.5.2.1.3
MC 510 121 Ex d	5/2-way, single sol.	G 1/2"	in-line	2.5.2.1.4
MC 520 501 Ex d	5/2-way, double sol.	G 1/8"	in-line	2.5.2.1.9
MC 520 701 Ex d	5/2-way, double sol.	G 1/4"	in-line	2.5.2.1.9
MC 520 121 Ex d	5/2-way, double sol.	G 1/2"	in-line	2.5.2.1.10
MC 53_501 Ex d	5/3-way, different version	G 1/8"	in-line	2.5.3.1.2
MC 53_701 Ex d	5/3-way, different version	G 1/4"	in-line	2.5.3.1.2
MC 53_121 Ex d	5/3-way, different version	G 1/2"	in-line	2.5.3.1.3

Valves with interface according to NAMUR-standard				
MNC 350 701 Ex d	3/2-way & 5/2-way	G 1/4"	1/4" NAMUR	2.9.1.3
MNC 310 701 Ex d	3/2-way, single sol.	G 1/4"	1/4" NAMUR	2.9.1.1.1
MNC 310 711 Ex d	3/2-way, single sol.	G 1/4"	1/4" NAMUR	2.9.1.1.1
MNC 310 121 Ex d	3/2-way, single sol.	G 1/2"	1/2" NAMUR	2.9.1.1.2
MNC 510 701 Ex d	5/2-way, single sol.	G 1/4"	1/4" NAMUR	2.9.1.2.1
MNC 510 711 Ex d	5/2-way, single sol.	G 1/4"	1/4" NAMUR	2.9.1.2.1
MNC 510 121 Ex d	5/2-way, single sol.	G 1/2"	1/2" NAMUR	2.9.1.2.2
MNC 520 701 Ex d	5/2-way, double sol.	G 1/4"	1/4" NAMUR	2.9.1.2.3
MNC 520 121 Ex d	5/2-way, double sol.	G 1/2"	1/2" NAMUR	2.9.1.2.3
MNC 53_701 Ex d	5/3-way, different version	G 1/4"	1/4" NAMUR	2.9.1.4
MNC 53_121 Ex d	5/3-way, different version	G 1/2"	1/2" NAMUR	2.9.1.4

Delivery contains valve with appropriate operator system, coil, manual and declaration of conformity.

ATEX-approved valves – Ex d – low temperature range – aluminium

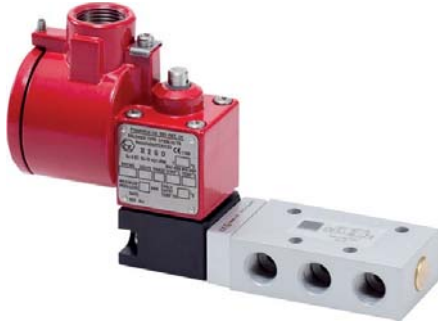

Material: Aluminum, anodized
 Zone: 1, 2, 21, 22
 Temperature range: -50°C ... +50°C ❄️
 Solenoid coil limited to +40°C
 Ignition protection type: Ex d – flameproof
 Temperature class: T6 (solenoid)

Interface between valve body and solenoid system according to CNOMO, therefore the types are called MC.

Base plate assembly due to solenoid coil is not possible.

Marking on valve

CE Ex II 2 G Ex h IIC T6 Gb
 -50°C ≤ Ta ≤ +50°C
 CE Ex II 2 D Ex h IIIC T80°C
 Db -50°C ≤ Ta ≤ +50°C

Flameproof solenoids type MA 52 EEx d IIC T6 24DC VES are displayed on page 2.14.3.6.5.

Example drawings including the solenoid are displayed on page 2.14.3.6.6.

The following solenoid valves are available:

Type	Function	Port size	Installation	Further information on valve on page
MC 310 501 TT Ex d	3/2-way, single sol.	G 1/8"	in-line	2.11.5.1.2
MOC 310 501 TT Ex d	3/2-way, n.o. single sol.	G 1/8"	in-line	2.11.5.1.2
MC 310 701 GTT Ex d	3/2-way, single sol.	G 1/4" - 1/4" NPT	in-line	2.11.5.1.2
MOC 310 701 GTT Ex d	3/2-way, n.o. single sol.	G 1/4" - 1/4" NPT	in-line	2.11.5.1.2
MC 320 501 TT Ex d	3/2-way, double sol.	G 1/8"	in-line	2.11.5.1.2
MC 320 701 GTT Ex d	3/2-way, double sol.	G 1/4"	in-line	2.11.5.1.2
MC 510 501 GTT Ex d	5/2-way, single sol.	G 1/8"	in-line	2.11.5.2.1
MC 510 701 GTT Ex d	5/2-way, single sol.	G 1/4" - 1/4" NPT	in-line	2.11.5.2.1
MC 520 501 GTT Ex d	5/2-way, double sol.	G 1/8"	in-line	2.11.5.2.2
MC 520 701 GTT Ex d	5/2-way, double sol.	G 1/4" - 1/4" NPT	in-line	2.11.5.2.2
MC 53_501 GTT Ex d	5/3-way, different version	G 1/8"	in-line	2.11.5.2.2
MC 53_701 GTT Ex d	5/3-way, different version	G 1/4" - 1/4" NPT	in-line	2.11.5.2.2

Valves with interface according to NAMUR-standard				
MNC 310 701 TT Ex d	3/2-way, single sol.	G 1/4" - 1/4" NPT	1/4" NAMUR	2.11.6.1
MNC 510 701 TT Ex d	5/2-way, single sol.	G 1/4" - 1/4" NPT	1/4" NAMUR	2.11.6.2.1
MNC 510 711 TT Ex d	5/2-way, single sol.	G 1/4"	1/4" NAMUR	2.11.6.2.1
MNC 520 701 TT Ex d	5/2-way, double sol.	G 1/4" - 1/4" NPT	1/4" NAMUR	2.11.6.2.2
MNC 531 701 TT Ex d	5/3-way, different version	G 1/4" - 1/4" NPT	1/4" NAMUR	2.11.6.2.2

Delivery contains valve with appropriate operator system, coil, manual and declaration of conformity.

ATEX-approved valves – Ex d – standard temperature range – stainless steel



Interface between valve body and solenoid system according to CNOMO, therefore the types are called MC.



Base plate assembly due to solenoid coil is not possible.

Flameproof solenoids type MA 52 EEx d IIC T6 24DC VES are displayed on page 2.14.3.6.5.

Example drawings including the solenoid are displayed on page 2.14.3.6.6.

Material: Stainless steel, 316L 
 Zone: 1, 2, 21, 22
 Temperature range: -10°C ... +50°C
 Solenoid coil limited to +40°C
 Ignition protection type: Ex d – flameproof
 Temperature class: T6 solenoid

Marking on valve

 II 2 G Ex h IIC T6 Gb
 -10°C ≤ Ta ≤ +50°C
 II 2 D Ex h IIC T80°C
 Db -10°C ≤ Ta ≤ +50°C

The following **solenoid valves** are available:

Type	Function	Port size	Installation	Further information on valve on page
MC 310 701 VES Ex d	3/2-way, single sol.	G 1/4"	in-line	2.12.4.2
MOC 310 701 VES Ex d	3/2-way, n.o. single sol.	G 1/4"	in-line	2.12.4.2
MC 310 121 VES Ex d	3/2-way, single sol.	G 1/2"	in-line	2.12.4.3
MC 510 701 VES Ex d	5/2-way, single sol.	G 1/4"	in-line	2.12.4.4
MC 510 121 VES Ex d	5/2-way, single sol.	G 1/2"	in-line	2.12.4.4
MC 520 701 VES Ex d	5/2-way, double sol.	G 1/4"	in-line	2.12.4.5
MC 520 121 VES Ex d	5/2-way, double sol.	G 1/2"	in-line	2.12.4.5
MC 53_ 701 VES Ex d	5/3-way, different version	G 1/4"	in-line	2.12.4.6
MC 53_ 121 VES Ex d	5/3-way, different version	G 1/2"	in-line	2.12.4.6
Valves with interface according to NAMUR-standard				
MNC 350 701 VES Ex d	3/2-way & 5/2-way	G 1/4"	1/4" NAMUR	2.12.5.3
MNC 310 701 VES Ex d	3/2-way, single sol.	G 1/4"	1/4" NAMUR	2.12.5.1
MNC 510 701 VES Ex d	5/2-way, single sol.	G 1/4"	1/4" NAMUR	2.12.5.2
MNC 520 701 VES Ex d	5/2-way, double sol.	G 1/4"	1/4" NAMUR	2.12.5.2

Delivery contains valve with appropriate operator system, coil, manual and declaration of conformity.

ATEX-approved valves – Ex d – low temperature range – stainless steel







Material: Stainless steel, 316L 
 Zone: 1, 2, 21, 22
 Temperature range: -50°C ... +50°C ❄️
 Solenoid coil limited to +40°C
 Ignition protection type: Ex d – flameproof
 Temperature class: T6 (solenoid)

Interface between valve body and solenoid system according to CNOMO, therefore the types are called MC.

Base plate assembly due to solenoid coil is not possible.

Marking on valve

  II 2 G Ex h IIC T6 Gb
 -50°C ≤ Ta ≤ +50°C
  II 2 D Ex h III C T80°C
 Db -50°C ≤ Ta ≤ +50°C

Flameproof solenoids type MA 52 EEx d IIC T6 24DC VES are displayed on page 2.14.3.6.5.

Example drawings including the solenoid are displayed on page 2.14.3.6.6.

The following solenoid valves are available:

Type	Function	Port size	Installation	Further information on valve on page
MC 310 701 VES TT Ex d	3/2-way, single sol.	G 1/4"	in-line	2.12.4.2
MOC 310 701 VES TT Ex d	3/2-way, n.o. single sol.	G 1/4"	in-line	2.12.4.2
MC 510 701 VES TT Ex d	5/2-way, single sol.	G 1/4"	in-line	2.12.4.4
MC 520 701 VES TT Ex d	5/2-way, double sol.	G 1/4"	in-line	2.12.4.5
MC 53_701 VES TT Ex d	5/3-way, different version	G 1/4"	in-line	2.12.4.6

Valves with interface according to NAMUR-standard				
Type	Function	Port size	Installation	Further information on valve on page
MNC 350 701 VES TT Ex d	3/2-way & 5/2-way	G 1/4"	1/4" NAMUR	2.12.5.3
MNC 310 701 VES TT Ex d	3/2-way, single sol.	G 1/4"	1/4" NAMUR	2.12.5.1
MNC 510 701 VES TT Ex d	5/2-way, single sol.	G 1/4"	1/4" NAMUR	2.12.5.2
MNC 520 701 VES TT Ex d	5/2-way, double sol.	G 1/4"	1/4" NAMUR	2.12.5.2

Delivery contains valve with appropriate operator system, coil, manual and declaration of conformity.

When this solenoid system is used in combination with "ATEX certified" mechanical components conforming EN 13463-1:2001 and PrEN 13463-5:2000, the entire valve can be used in explosive hazardous environment zone 1, 2, 21 and 22.

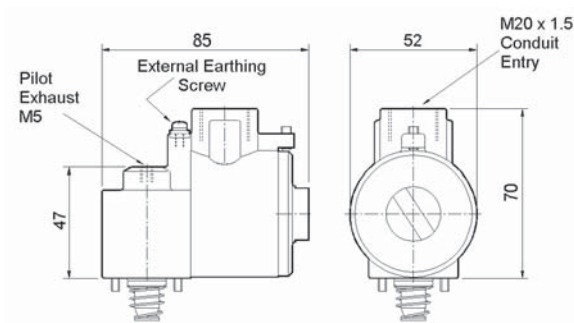

MA 52 EEx D IIC T₆ (VES)

ATEX approved flameproof coil for gas and dust explosion hazardous environment.
Solenoids with IEC-Ex certificate on request.

Voltage: 24VDC, 110VAC, 240VAC
Voltage tolerance: - 10...+ 10 %
Relative duty cycle: 100 %
Temperature range: T6: -65°C...+40°C
T4: -65°C...+60°C, valve limited to -50°C

Ignition protection type: flameproof

Protection according to ENBS60529 : 1992 : IP 66 with appropriate cable gland

Material solenoid coil: Stainless Steel

Coil rating according to DIN VDE 0580: Class F

Cable Gland: M20 x 1.5

Marking on coil: DC-Version:
  II 2G Ex db IIC T6 Gb
 II 2D Ex tb IIIC T85°C Db
 AC-Versions:
  II 2G Ex db IIC T4 Gb
 II 2D Ex tb IIIC T135°C Db

glands can be supplied on request.

Technical details pilot head :

Material : Standard: Aluminum
Type VES: Stainless Steel,
manual override and nozzle
made of brass

Manual override: bistable to turn,
others on request

The ATEX approval is only valid as long as the associated components are used.

Delivery content without cable gland. Ex d rated cable

Type	Operating press.	Power cons.	Temperature class
MA 52 EEx d IIC T6 24 DC	max. 10 bar	3,0 Watt	T6 (85° C)
MA 52 EEx d IIC T6 24 DC VES	max. 10 bar	3,0 Watt	T6 (85° C)
MA 52 EEx d IIC T4 110AC	max. 10 bar	9,6 VA	T4 (135° C)
MA 52 EEx d IIC T4 110AC VES	max. 10 bar	9,6 VA	T4 (135° C)
MA 52 EEx d IIC T4 240AC	max. 10 bar	9,6 VA	T4 (135° C)
MA 52 EEx d IIC T4 240AC VES	max. 10 bar	9,6 VA	T4 (135° C)

Example drawings of solenoid valves with Ex d solenoid system

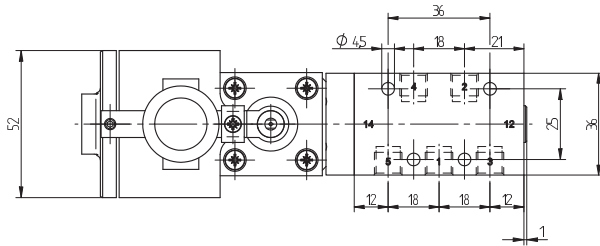

MC 510 501 Ex d

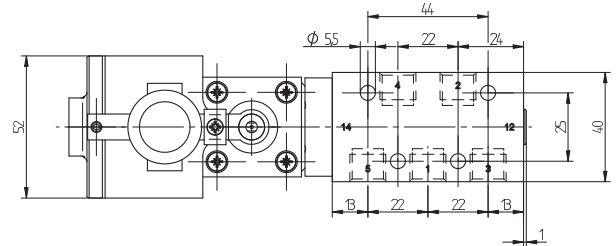

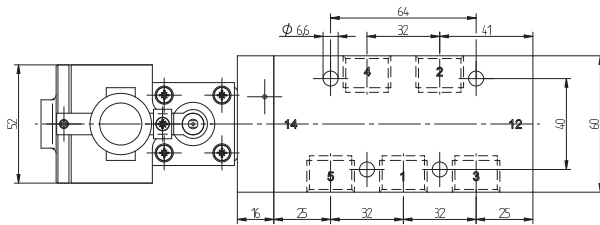

MC 510 701 Ex d/
MNC 510 701 Ex d



MC 510 121 Ex d/
MNC 510 121 Ex d

ATEX-approved valves – Ex dm – standard temperature range – aluminum



Material: Aluminum, anodized
 Zone: 1, 2, 21, 22
 Temperature range: -10°C ... +50°C
 Ignition protection type: Ex dm (encapsulated-flameproof with junction box)
 Temperature class: T5
 Marking on valve:  II 2 G Ex h IIC T6 Gb
 -10°C ≤ Ta ≤ +50°C
 II 2 D Ex h IIC T80°C
 Db -10°C ≤ Ta ≤ +50°C

Base plate assembly due to width of solenoid coil (36 mm) is not possible.

Encapsulated flameproof solenoids are displayed on page 2.14.3.7.5.

A low temperature version for -20°C ... +50°C is also available on request. Please note that the system is restricted by the minimum ambient temperature for the coil of -20°C.



The following solenoid valves are available:

Type	Function	Port size	Installation	Further inform. on valve	Valves with interface according to NAMUR-standard				
Type	Function	Port size	Installation	Further inform. on valve	Type	Function	Port size	Installation	Further inform. on valve
MH 210 501 Ex dm	2/2-way, single sol.	G 1/8"	in-line	2.5.1.1.13	MNH 350 701 Ex dm	3/2-way & 5/2-way	G 1/4"	1/4" NAMUR	2.9.1.3
MH 210 701 Ex dm	2/2-way, single sol.	G 1/4"	in-line	2.5.1.1.13	MNH 310 701 Ex dm	3/2-way, single sol.	G 1/4"	1/4" NAMUR	2.9.1.1.1
MH 311 012 Ex dm	3/2-way direct acting	M5	in-line	2.5.1.1.2	MNH 310 711 Ex dm	3/2-way, single sol.	G 1/4"	1/4" NAMUR	2.9.1.1.1
MH 311 015 Ex dm	3/2-way direct acting	G 1/8"	in-line	2.5.1.1.2	MNH 310 121 Ex dm	3/2-way, single sol.	G 1/2"	1/2" NAMUR	2.9.1.1.2
MH 310 501 Ex dm	3/2-way, single sol.	G 1/8"	in-line	2.5.1.1.14	MNH 510 701 Ex dm	5/2-way, single sol.	G 1/4"	1/4" NAMUR	2.9.1.2.1
MOH 310 501 Ex dm	3/2-way, n.o. single sol.	G 1/8"	in-line	2.5.1.1.14	MNH 510 711 Ex dm	5/2-way, single sol.	G 1/4"	1/4" NAMUR	2.9.1.2.1
MH 310 701 Ex dm	3/2-way, single sol.	G 1/4"	in-line	2.5.1.1.14	MNH 510 121 Ex dm	5/2-way, single sol.	G 1/2"	1/2" NAMUR	2.9.1.2.2
MOH 310 701 Ex dm	3/2-way, n.o. single sol.	G 1/4"	in-line	2.5.1.1.14	MNH 520 701 Ex dm	5/2-way, double sol.	G 1/4"	1/4" NAMUR	2.9.1.2.3
MH 310 801 Ex dm	3/2-way, single sol.	G 1/4"	in-line	2.5.1.1.14	MNH 520 121 Ex dm	5/2-way, double sol.	G 1/2"	1/2" NAMUR	2.9.1.2.3
MOH 310 801 Ex dm	3/2-way, n.o. single sol.	G 1/4"	in-line	2.5.1.1.14	MNH 53_701 Ex dm	5/3-way, different version	G 1/4"	1/4" NAMUR	2.9.1.4
MH 310 101 Ex dm	3/2-way, single sol.	G 3/8"	in-line	2.5.1.1.15	MNH 53_121 Ex dm	5/3-way, different version	G 1/2"	1/2" NAMUR	2.9.1.4
MOH 310 101 Ex dm	3/2-way, n.o. single sol.	G 3/8"	in-line	2.5.1.1.15					
MH 310 121 Ex dm	3/2-way, single sol.	G 1/2"	in-line	2.5.1.1.15					
MOH 310 121 Ex dm	3/2-way, n.o. single sol.	G 1/2"	in-line	2.5.1.1.15					
MH 320 501 Ex dm	3/2-way, double sol.	G 1/8"	in-line	2.5.1.1.18					
MH 320 701 Ex dm	3/2-way, double sol.	G 1/4"	in-line	2.5.1.1.18					
MH 320 801 Ex dm	3/2-way, double sol.	G 1/4"	in-line	2.5.1.1.18					
MH 320 101 Ex dm	3/2-way, double sol.	G 3/8"	in-line	2.5.1.1.19					
MH 320 121 Ex dm	3/2-way, double sol.	G 1/2"	in-line	2.5.1.1.19					
MH 510 501 Ex dm	5/2-way, single sol.	G 1/8"	in-line	2.5.2.1.3					
MH 510 701 Ex dm	5/2-way, single sol.	G 1/4"	in-line	2.5.2.1.3					
MH 510 801 Ex dm	5/2-way, single sol.	G 1/4"	in-line	2.5.2.1.3					
MH 510 101 Ex dm	5/2-way, single sol.	G 3/8"	in-line	2.5.2.1.4					
MH 510 121 Ex dm	5/2-way, single sol.	G 1/2"	in-line	2.5.2.1.4					
MH 520 501 Ex dm	5/2-way, double sol.	G 1/8"	in-line	2.5.2.1.9					
MH 520 701 Ex dm	5/2-way, double sol.	G 1/4"	in-line	2.5.2.1.9					
MH 520 801 Ex dm	5/2-way, double sol.	G 1/4"	in-line	2.5.2.1.9					
MH 520 101 Ex dm	5/2-way, double sol.	G 3/8"	in-line	2.5.2.1.10					
MH 520 121 Ex dm	5/2-way, double sol.	G 1/2"	in-line	2.5.2.1.10					
MH 53_501 Ex dm	5/3-way, different version	G 1/8"	in-line	2.5.3.1.2					
MH 53_701 Ex dm	5/3-way, different version	G 1/4"	in-line	2.5.3.1.2					
MH 53_801 Ex dm	5/3-way, different version	G 1/4"	in-line	2.5.3.1.2					
MH 53_101 Ex dm	5/3-way, different version	G 3/8"	in-line	2.5.3.1.3					
MH 53_121 Ex dm	5/3-way, different version	G 1/2"	in-line	2.5.3.1.3					

Delivery contains valve with appropriate operator system, coil, manual and declaration of conformity.

ATEX-approved valves – Ex dm – standard temperature range – stainless steel



Material:	Stainless steel, 316L 
Zone:	1, 2, 21, 22
Temperature range:	-10°C ... +50°C
Ignition protection type:	Ex dm (encapsulated-flameproof with junction box)
Temperature class:	T5
Marking on valve:	 II 2 G Ex h IIC T6 Gb -10°C ≤ Ta ≤ +50°C
	 II 2 D Ex h IIC T80°C Db -10°C ≤ Ta ≤ +50°C

If the coil will be used with a NAMUR-valve of series 700, an 8 mm distance plate is required. Please contact us.

Encapsulated flameproof solenoids are displayed on page 2.14.3.7.5.

A low temperature version for -20°C ... +50°C is also available on request. Please note that the system is restricted by the minimum ambiente temperature for the coil of -20°C.

The following **solenoid valves** are available:

Type	Function	Port size	Installation	Further information on valve on page
MH 311 015 VES Ex dm	3/2-way direct acting	G 1/8"	in-line	2.12.4.1
MH 310 701 VES Ex dm	3/2-way, single sol.	G 1/4"	in-line	2.12.4.2
MOH 310 701 VES Ex dm	3/2-way, n.o. single sol.	G 1/4"	in-line	2.12.4.2
MH 310 121 VES Ex dm	3/2-way, single sol.	G 1/2"	in-line	2.12.4.3
MOH 310 121 VES Ex dm	3/2-way, n.o. single sol.	G 1/2"	in-line	2.12.4.3
MH 510 701 VES Ex dm	5/2-way, single sol.	G 1/4"	in-line	2.12.4.4
MH 510 121 VES Ex dm	5/2-way, single sol.	G 1/2"	in-line	2.12.4.4
MH 520 701 VES Ex dm	5/2-way, double sol.	G 1/4"	in-line	2.12.4.5
MH 520 121 VES Ex dm	5/2-way, double sol.	G 1/2"	in-line	2.12.4.5
MH 53_701 VES Ex dm	5/3-way, different version	G 1/4"	in-line	2.12.4.6
MH 53_121 VES Ex dm	5/3-way, different version	G 1/2"	in-line	2.12.4.6

Valves with interface according to NAMUR-standard

MNH 350 701 VES Ex dm	3/2-way & 5/2-way	G 1/4"	1/4" NAMUR	2.12.5.3
MNH 310 701 VES Ex dm	3/2-way, single sol.	G 1/4"	1/4" NAMUR	2.12.5.1
MNH 510 701 VES Ex dm	5/2-way, single sol.	G 1/4"	1/4" NAMUR	2.12.5.2
MNH 520 701 VES Ex dm	5/2-way, double sol.	G 1/4"	1/4" NAMUR	2.12.5.2

When this solenoid system is used in combination with "ATEX certified" mechanical components conforming EN 13463-1:2001 and PrEN 13463-5:2000, the entire valve can be used in explosive hazardous environment zone 1, 2, 21 and 22.

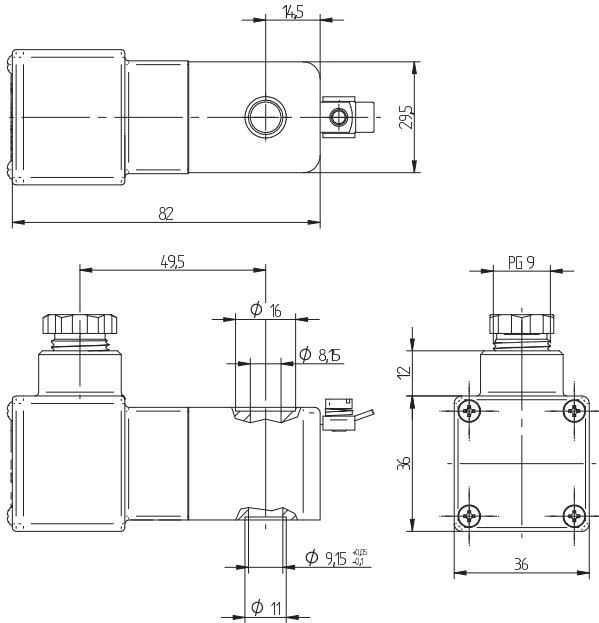

MA 36 EEx dm IIC T5_ _



ATEX approved encapsulated coil with flameproof junction box for gas and dust explosion-hazardous environment.

Voltages: 12VDC, 24VDC, 24VAC, 110VAC, 230VAC

Voltage tolerance: - 10...+ 10%

Relative duty cycle: 100 %

Temperature range: -20°C...+50°C

Ignition protection type: Coil encapsulated, junction box flameproof

Protection with connector according to EN 60529: IP 66

Moulding material: Thermoplasticpolyester

Coil rating according to DIN VDE 0580: Class F

Cable Gland: PG 9 DIN 40-430 for cable diameters 6 – 8 mm

Marking on coil:  II 2G Ex db mb IIC T5 Gb
II 2D Ex tb IIIC T95°C IP66 Db

As the coil is 36 mm wide, a spacer plate called "ZPN 8" has to be used, in case of combination with our NAMUR-valve series 700. If used with NAMUR-valve series 121 a spacer plate called "ZPN 6-5" has to be used. You can find both plates on page 2.10.12.

The ATEX approval is only valid as long as the associated components are used.

Type	Operating press.	Power cons.	Temperature class
MA 36 EEx dm IIC T5 12DC	max. 10 bar	3,0 Watt	T5 (100 °C)
MA 36 EEx dm IIC T5 24DC	max. 10 bar	3,0 Watt	T5 (100 °C)
MA 36 EEx dm IIC T5 24AC	max. 10 bar	4,8 VA	T5 (100 °C)
MA 36 EEx dm IIC T5 110AC	max. 10 bar	4,8 VA	T5 (100 °C)
MA 36 EEx dm IIC T5 230AC	max. 10 bar	4,8 VA	T5 (100 °C)

CBN 700 K Ex/ CBN 700 K EB Ex

Controlblock for butterfly valves with inflatable valve-seat

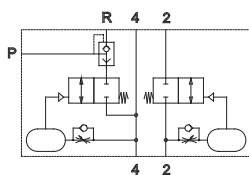

CBN 700 K Ex

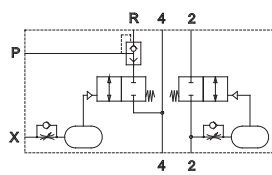

CBN 700 K EB Ex



Control block for double acting actuators with interface according to 1/4" NAMUR-standard, to be used on process-valves with inflatable valve seat.

The control-block receives it's signals to open and close from a standard 5/2-way NAMUR-valve. The block is to be put between the actuator and the NAMUR-valve (flange-version). The closing-signal is fed through to the actuator, the seal is inflated with time-delay.

When the process-valves is to be closed first the seal is deflated, with time-delay the actuator opens the process-valve.

Opening- and closing-time-delay can be adjusted independently but they are related to the operating pressure.

At 6 bar time-delay can be adjusted between 0 and 2 seconds.

Type **CBN 700 K EB Ex** with additional port X: pressurizing of the inflatable seal does not start before a pneumatic signal is received.

If the valve is required with G 1/4" ports, plate GPN 1/4 can be added. For details please refer to page 2.10.12.

Delivery includes 2 screws, 2 O-rings, 2 protection caps.

Please note:

If a pressure regulator is used between the CBN 700 (port P) and the inflatable seal, an additional quick exhaust valve is needed to exhaust te seal.

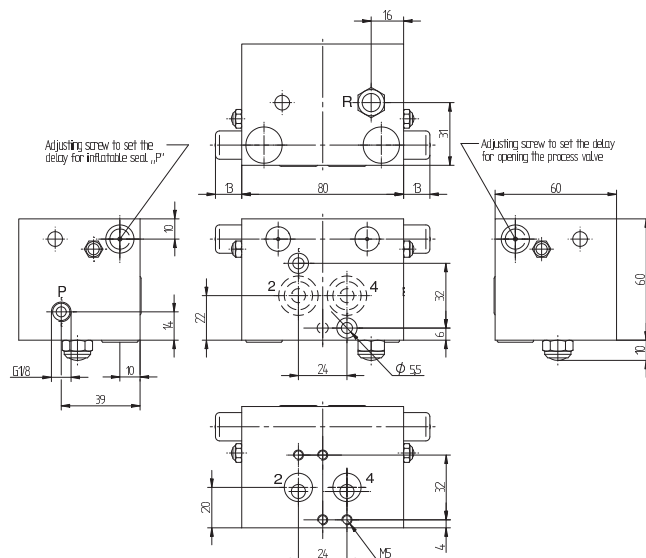

CBN 700 K Ex

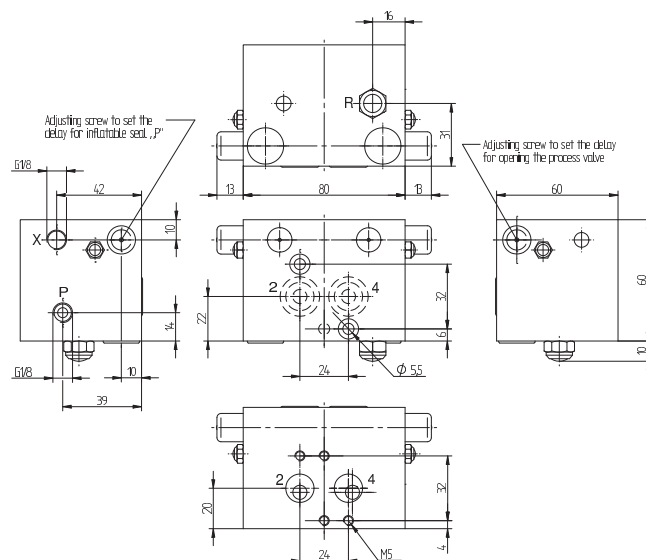

CBN 700 K EB Ex

Marking on valve: **CE Ex** II 3 G Ex h IIC T6 Gb -10°C ≤ Ta ≤ +50°C
CE Ex II 3 D Ex h IIIC T80°C Db -10°C ≤ Ta ≤ +50°C

Zone: 2 and 22

Type	NAMUR	Port P	Port X	Air flow act.	Operating press.	Air flow seal	Weight
CBN 700 K Ex	1/4"	G 1/8"		900 l/min	3 - 10 bar	400 l/min	0,80 kg
CBN 700 K EB Ex	1/4"	G 1/8"	G 1/8"	900 l/min	3 - 10 bar	400 l/min	0,80 kg

SENR 207 01 Ex

Quick-exhaust-block with non-return valve

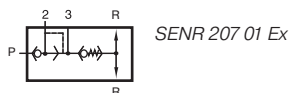

The valve is designed for fast closing of spring-return actuators with 1/4" NAMUR-interface.

Any 3/2-way valve can be used as pilot valve. The connection towards the pilot valve is G 1/4" ported and for NAMUR-valves with the 1/4" NAMUR-interface.

The block assures that only compressed air that has been used to open the actuator is used in the spring-chamber (non-return-function). Excess air is released very fast by the quick-exhaust valve, exhaust-port G 1/2", orifice 10 mm. The non-return valve makes absolutely sure that no ambient atmosphere can be sucked into the actuator.

Two exhaust-ports R allow that the product can always be assembled so the silencer faces downwards.

Delivery includes 2 screws, 2 O-rings, 1/2" plug for port R.

Marking von valve:

II 3 G Ex h IIC T6 Gb
 -10°C ≤ Ta ≤ +50°C
 II 3 D Ex h IIIC T80°C
 Db -10°C ≤ Ta ≤ +50°C

Zone: 2 and 22

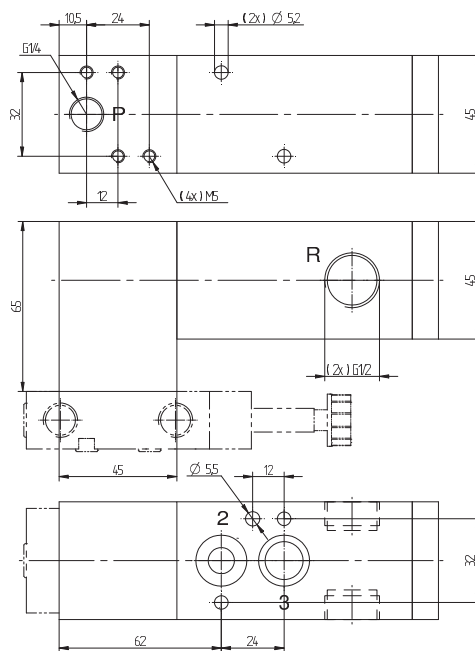

SENR 207 01 Ex

Function:

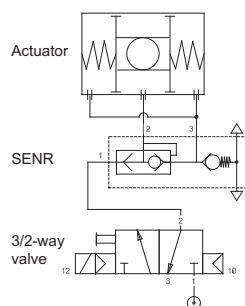

Type	NAMUR Port P	Port R	Air flow P to 2	Air flow exhaust	Operating press.	Weight
SENR 207 01 Ex	1/4"	G 1/4" - 1/4" NAMUR	G 1/2"	1250 l/min	2500 l/min	2 - 10 bar 0,85 kg

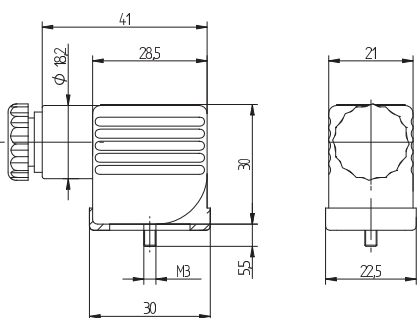
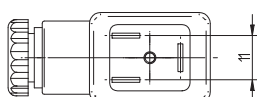

ST 22 Ex

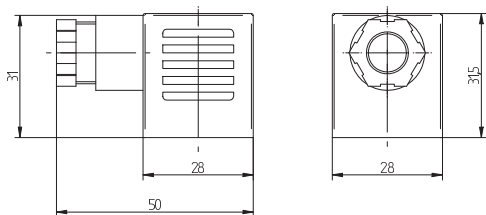
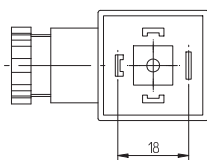

ST 30 Ex ia / ST 30 Ex nA



Connectors as accessories for explosion-proof coils.

Type ST 22 Ex

Connector to be used in combination with MA 22 Ex nA. Connector is classified for zone 2 and 22 cat. IIG/D. Includes flat seal.

Type ST 30 Ex ia

Connector which is to be used in combination with the coil type MA 30 Ex ia tD II CT6 24DC. Connector has no separate ATEX certification. Connector is classified for zone 21, cat. IID. Can also be used in combination with intrinsically safe coils in zone 1 (cat. IIG). Includes flat silicon seal.

Type ST 30 Ex nA

Connector to be used in combination with MA 30 Ex na. Connector is classified for zone 2 and 22, cat. IIIG and IIID. Includes profiled NBR seal.

Other connectors are available on request.

Type	Form	LED	VAR	Operat. voltage	Max. current	Cable diameter
ST 22 Ex	Industrial	no	no	0 - 250 V	10 A	6 - 8 mm
ST 30 Ex ia	A, ISO 4400	no	no	0 - 250 V	10 A	6 - 8 mm
ST 30 Ex nA	A, ISO 4400	no	no	0 - 250 V	10 A	4 - 8 mm